

# Mouldings

## RETAIL PRICE LIST

Prices inc. GST

# SUBLACO RESTORATION

EST. 1981

## Skirtings

MEDIUM DENSITY FIBREBOARD (MDF), MOISTURE RESISTANCE (MR)

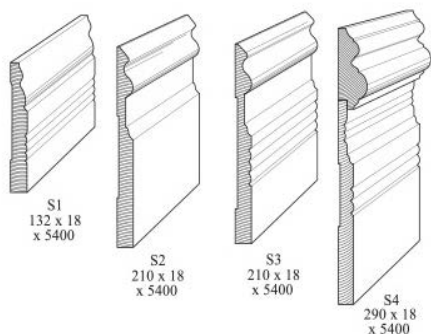

DIMENSIONS (MM)	LENGTHS (M)	L/M
132 x 18 - S1 (Primed)	2.7 / 5.4	\$ 7.15
210 x 18 - S2 (Primed)	2.7 / 5.4	\$ 9.61
210 x 18 - S3	2.7 / 5.4	\$ 9.61
290 x 18 - S4	2.7 / 5.4	\$ 19.95

## Skirtings

MEDIUM DENSITY FIBREBOARD (MDF), MOISTURE RESISTANCE (MR)

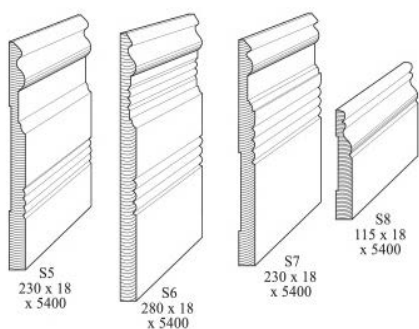

DIMENSIONS (MM)	LENGTHS (M)	L/M
230 x 18 - S5 (Primed)	2.7 / 5.4	\$ 10.74
280 x 18 - S6	2.7 / 5.4	\$ 16.33
230 x 18 - S7	2.7 / 5.4	\$ 10.74
115 x 18 - S8 (Primed)	2.7 / 5.4	\$ 5.98

## Skirtings

MEDIUM DENSITY FIBREBOARD (MDF), MOISTURE RESISTANCE (MR)

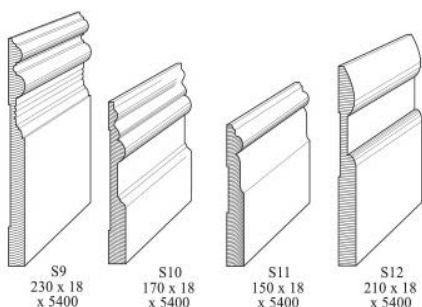

DIMENSIONS (MM)	LENGTHS (M)	L/M
230 x 18 - S9	2.7 / 5.4	\$ 11.60
170 x 18 - S10 (Primed)	2.7 / 5.4	\$ 7.44
150 x 18 - S11 (Primed)	2.7 / 5.4	\$ 7.66
210 x 18 - S12 (Primed)	2.7 / 5.4	\$ 9.61

# SUBLACO RESTORATION

EST. 1981

## Skirtings

MEDIUM DENSITY FIBREBOARD (MDF), MOISTURE RESISTANCE (MR)

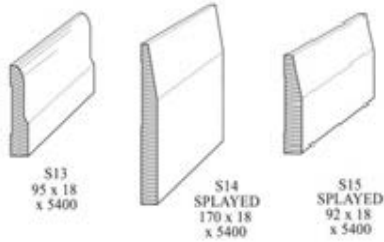

DIMENSIONS (MM)	LENGTHS (M)	L/M
95 x 18 - S13 (Primed)	2.7 / 5.4	\$ 4.95
170 x 18 - S14 Splayed (Primed)	2.7 / 5.4	\$ 7.44
92 x 18 - S15 Splayed (Primed)	2.7 / 5.4	\$ 4.95

## WA Colonial Skirtings

MEDIUM DENSITY FIBREBOARD (MDF), MOISTURE RESISTANCE (MR)

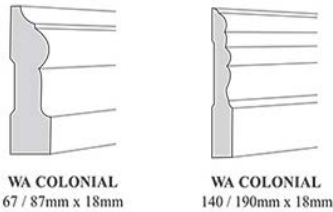

DIMENSIONS (MM)	LENGTHS (M)	L/M
67 x 18 (Primed)	2.7 / 5.4	\$ 2.29
87 x 18 (Primed)	2.7 / 5.4	\$ 3.28
140 x 18 (Primed)	2.7 / 5.4	\$ 4.86
190 x 18 (Primed)	2.7 / 5.4	\$ 7.55

## Single Bullnosed Skirtings

MEDIUM DENSITY FIBREBOARD (MDF), MOISTURE RESISTANCE (MR)

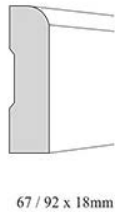

DIMENSIONS (MM)	LENGTHS (M)	L/M
67 x 18 (Primed)	2.7 / 5.4	\$ 2.29
92 x 18 (Primed)	2.7 / 5.4	\$ 3.28

## Half Splayed Skirtings

MEDIUM DENSITY FIBREBOARD (MDF), MOISTURE RESISTANCE (MR)

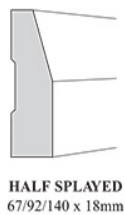

DIMENSIONS (MM)	LENGTHS (M)	L/M
67 x 18 (Primed)	2.7 / 5.4	\$ 2.29
92 x 18 (Primed)	2.7 / 5.4	\$ 3.28
140 x 18 (Primed)	2.7 / 5.4	\$ 4.86

# SUBLACO RESTORATION

EST. 1981

## Lambs Tounge Skirtings

MEDIUM DENSITY FIBREBOARD (MDF), MOISTURE RESISTANCE (MR)

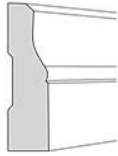

LAMBS TONGUE  
67 / 92 / 140 x 18mm

DIMENSIONS (MM)	LENGTHS (M)	L/M
67 x 18 (Primed)	2.7 / 5.4	\$ 2.29
92 x 18 (Primed)	2.7 / 5.4	\$ 3.28
140 x 18 (Primed)	2.7 / 5.4	\$ 4.86

## WA Federation Skirtings

MEDIUM DENSITY FIBREBOARD (MDF), MOISTURE RESISTANCE (MR)

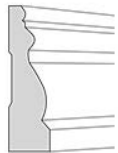

WA FEDERATION  
65 / 80 / 125 x 18mm

DIMENSIONS (MM)	LENGTHS (M)	L/M
65 x 18 (Primed)	2.7 / 5.4	\$ 2.29
80 x 18 (Primed)	2.7 / 5.4	\$ 3.28
125 x 18 (Primed)	2.7 / 5.4	\$ 4.75

## Skirting Blocks

MEDIUM DENSITY FIBREBOARD (MDF), MOISTURE RESISTANCE (MR)

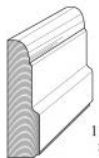

SB1  
115 x 32  
x 5400

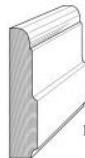

SB2  
140 x 32  
x 5400

DIMENSIONS (MM)	LENGTHS (M)	L/M
115 x 32 - SB1	2.7 / 5.4	\$ 9.61
140 x 32 - SB2	2.7 / 5.4	\$ 10.71

## Skirting Blocks

MEDIUM DENSITY FIBREBOARD (MDF), MOISTURE RESISTANCE (MR)



SB3  
115 x 32  
x 5400

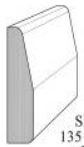

SB4  
135 x 32  
x 5400



SB5  
80 x 25  
x 5400

DIMENSIONS (MM)	LENGTHS (M)	L/M
115 x 32 - SB3	2.7 / 5.4	\$ 9.61
135 x 32 - SB4	2.7 / 5.4	\$ 10.71
80 x 25 - SB5	2.7 / 5.4	\$ 5.89

# SUBLACO RESTORATION

EST. 1981

## Architraves

MEDIUM DENSITY FIBREBOARD (MDF), MOISTURE RESISTANCE (MR)

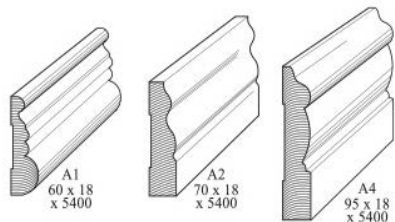

DIMENSIONS (MM)	LENGTHS (M)	L/M
60 x 18 - A1	2.7 / 5.4	\$ 3.68
70 x 18 - A2	2.7 / 5.4	\$ 3.94
95 x 18 - A4 (Primed)	2.7 / 5.4	\$ 4.91

## Architraves

MEDIUM DENSITY FIBREBOARD (MDF), MOISTURE RESISTANCE (MR)

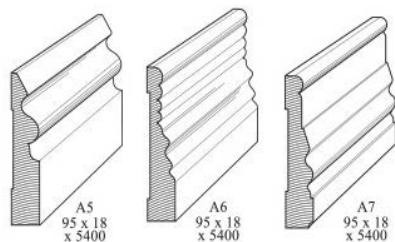

DIMENSIONS (MM)	LENGTHS (M)	L/M
95 x 18 - A5	2.7 / 5.4	\$ 4.91
95 x 18 - A6 (Primed)	2.7 / 5.4	\$ 4.91
95 x 18 - A7 (Primed)	2.7 / 5.4	\$ 4.91

## Architraves

MEDIUM DENSITY FIBREBOARD (MDF), MOISTURE RESISTANCE (MR)

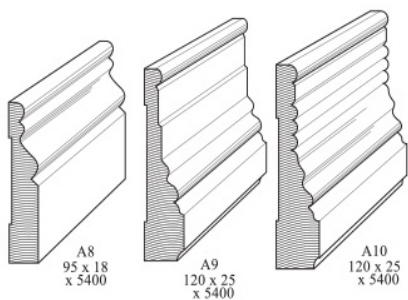

DIMENSIONS (MM)	LENGTHS (M)	L/M
95 x 18 x - A8 (Primed)	2.7 / 5.4	\$ 4.91
120 x 25 - A9	2.7 / 5.4	\$ 8.03
120 x 25 - A10	2.7 / 5.4	\$ 8.03

## Architraves

MEDIUM DENSITY FIBREBOARD (MDF), MOISTURE RESISTANCE (MR)

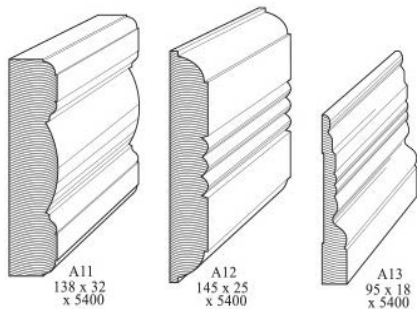

DIMENSIONS (MM)	LENGTHS (M)	L/M
138 x 32 - A11	2.7 / 5.4	\$ 10.71
145 x 25 - A12	2.7 / 5.4	\$ 9.40
95 x 18 - A13 (Primed)	2.7 / 5.4	\$ 4.91

# SUBLACO RESTORATION

EST. 1981

## Architraves

MEDIUM DENSITY FIBREBOARD (MDF), MOISTURE RESISTANCE (MR)

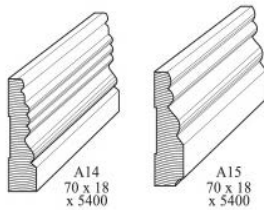

DIMENSIONS (MM)	LENGTHS (M)	L/M
70 x 18 - A14	2.7 / 5.4	\$ 3.94
70 x 18 - A15	2.7 / 5.4	\$ 3.94

## WA Colonial Architraves

MEDIUM DENSITY FIBREBOARD (MDF), HIGH MOISTURE RESISTANCE (MR)

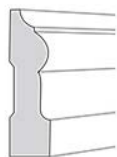

WA COLONIAL  
67 / 87mm x 18mm

DIMENSIONS (MM)	LENGTHS (M)	L/M
67 x 18 (Primed)	2.7 / 5.4	\$ 2.29
87 x 18 (Primed)	2.7 / 5.4	\$ 3.28

## Double Bullnosed Architraves

MEDIUM DENSITY FIBREBOARD (MDF), MOISTURE RESISTANCE (MR)

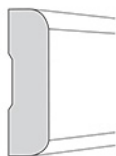

DOUBLE BULLNOSED ARCH  
67mm x 18mm

DIMENSIONS (MM)	LENGTHS (M)	L/M
42 x 18 (Primed)	2.7 / 5.4	\$ 1.72
67 x 18 (Primed)	2.7 / 5.4	\$ 2.29

## Single Bullnosed Architraves

MEDIUM DENSITY FIBREBOARD (MDF), MOISTURE RESISTANCE (MR)

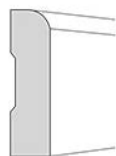

67 / 92 x 18mm

DIMENSIONS (MM)	LENGTHS (M)	L/M
67 x 18 (Primed)	2.7 / 5.4	\$ 2.29
92 x 18 (Primed)	2.7 / 5.4	\$ 3.28

# SUBLACO RESTORATION

EST. 1981

## Half Splayed Architraves

MEDIUM DENSITY FIBREBOARD (MDF), MOISTURE RESISTANCE (MR)

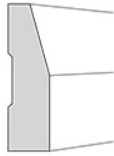

HALF SPLAYED  
67/92/140 x 18mm

DIMENSIONS (MM)	LENGTHS (M)	L/M
67 x 18 (Primed)	2.7 / 5.4	\$ 2.29
92 x 18 (Primed)	2.7 / 5.4	\$ 3.28
140 x 18 (Primed)	2.7 / 5.4	\$ 4.86

## Lambs Tounge Architraves

MEDIUM DENSITY FIBREBOARD (MDF), MOISTURE RESISTANCE (MR)

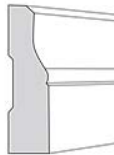

LAMBS TONGUE  
67 / 92 x 18mm

DIMENSIONS (MM)	LENGTHS (M)	L/M
67 x 18 (Primed)	2.7 / 5.4	\$ 2.29
92 x 18 (Primed)	2.7 / 5.4	\$ 3.28

## WA Federation Architraves

MEDIUM DENSITY FIBREBOARD (MDF), MOISTURE RESISTANCE (MR)

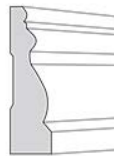

WA FEDERATION  
65 / 80 x 18mm

DIMENSIONS (MM)	LENGTHS (M)	L/M
65 x 18 (Primed)	2.7 / 5.4	\$ 2.29
80 x 18 (Primed)	2.7 / 5.4	\$ 3.28

## External Architraves & Skirtings

H3 LOSP TREATED PINE

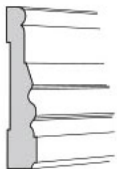

A7  
88 x 18

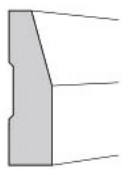

HALF SPLAYED  
88 x 18

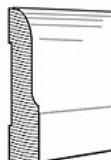

S13  
88 X 18

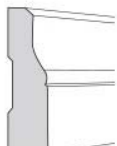

LAMBS TONGUE  
88 x 18  
x 5400

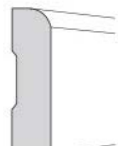

SINGLE BULLNOSED  
88 x 18  
x 5400

DIMENSIONS (MM)	LENGTHS (M)	L/M
88 x 18 - A7	2.7 / 5.4	\$ 8.30
88 x 18 - Half Splayed	2.7 / 5.4	\$ 8.30
88 x 18 - S13	2.7 / 5.4	\$ 8.30
88 x 18 - Lambs Tounge	2.7 / 5.4	\$ 8.30
88 x 18 - Single Bullnose	2.7 / 5.4	\$ 8.30

# SUBLACO RESTORATION

EST. 1981

## Quads

MEDIUM DENSITY FIBREBOARD (MDF), MOISTURE RESISTANCE (MR)

Jarrah lengths available on request.



DIMENSIONS (MM)	LENGTHS (M)	L/M
18 x 18 - MDF (Primed)	2.7 / 5.4	\$ 1.35
32 x 32 - MDF	2.7 / 5.4	\$ 4.99
12 x 12 - Jarrah		\$ 4.15
18 x 18 - Jarrah		\$ 5.70
32 x 32 - Jarrah		\$ 13.15

## Door Stops

MEDIUM DENSITY FIBREBOARD (MDF), MOISTURE RESISTANCE (MR)



30 x 12  
MDF



42 x 12  
MDF



40 x 12  
Jarrah

DIMENSIONS (MM)	LENGTHS (M)	L/M
30 x 12 - MDF (Primed)	2.7 / 5.4	\$ 1.23
42 x 12 - MDF (Primed)	2.7 / 5.4	\$ 1.34
40 x 12 - Jarrah	2.1 / 3.0	\$ 5.50

## Scotias

MEDIUM DENSITY FIBREBOARD (MDF), MOISTURE RESISTANCE (MR)



DIMENSIONS (MM)	LENGTHS (M)	L/M
42 x 18 - MDF (Primed)	2.7 / 5.4	\$ 2.11
30 x 30 - Jarrah		\$ 11.15

## Cornices

MEDIUM DENSITY FIBREBOARD (MDF), MOISTURE RESISTANCE (MR)



C1  
93 x 18

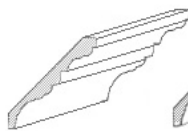

C13  
128 x 18

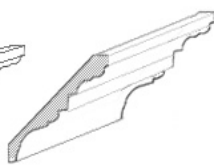

C14  
180 x 18

DIMENSIONS (MM)	LENGTHS (M)	L/M
93 x 18 - C1	2.7 / 5.4	\$ 5.70
128 x 18 - C13	2.7 / 5.4	\$ 7.00
180 x 18 - C14	2.7 / 5.4	\$ 9.40



# SUBLACO RESTORATION

EST. 1981

## Nosing

MEDIUM DENSITY FIBREBOARD (MDF), MOISTURE RESISTANCE (MR)

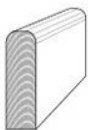

N1  
100 x 32

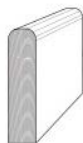

N2  
125 x 32

DIMENSIONS (MM)	LENGTHS (M)	L/M
100 x 32 - N1	2.7 / 5.4	\$ 7.60
125 x 32 - N2	2.7 / 5.4	\$ 9.00

## Nosing

MEDIUM DENSITY FIBREBOARD (MDF), MOISTURE RESISTANCE (MR)



N3  
150 x 32



N5  
175 x 32

DIMENSIONS (MM)	LENGTHS (M)	L/M
150 x 32 - N3	2.7 / 5.4	\$ 10.45
175 x 32 - N5	2.7 / 5.4	\$ 11.40

## Nosing

MEDIUM DENSITY FIBREBOARD (MDF), MOISTURE RESISTANCE (MR)



DIMENSIONS (MM)	LENGTHS (M)	L/M
170 x 25 (Primed)	2.7 / 5.4	\$ 12.10

## Square Dressed

MEDIUM DENSITY FIBREBOARD (MDF), MOISTURE RESISTANCE (MR)



30 x 12



42 x 12

DIMENSIONS (MM)	LENGTHS (M)	L/M
30 x 12 (Primed)	2.7 / 5.4	\$ 1.23
42 x 12 (Primed)	2.7 / 5.4	\$ 1.34

## Square Dressed

MEDIUM DENSITY FIBREBOARD (MDF), MOISTURE RESISTANCE (MR)



42 x 18



67 x 18



92 x 18

DIMENSIONS (MM)	LENGTHS (M)	L/M
42 x 18 (Primed)	2.7 / 5.4	\$ 1.72
67 x 18 (Primed)	2.7 / 5.4	\$ 2.29
92 x 18 (Primed)	2.7 / 5.4	\$ 3.28

# SUBLACO RESTORATION

EST. 1981

## Picture Rails

MEDIUM DENSITY FIBREBOARD (MDF), MOISTURE RESISTANCE (MR)

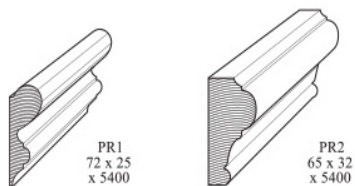

DIMENSIONS (MM)	LENGTHS (M)	L/M
72 x 25 - PR1	2.7 / 5.4	\$ 6.25
65 x 32 - PR2	2.7 / 5.4	\$ 7.20

## Picture Rails

MEDIUM DENSITY FIBREBOARD (MDF), MOISTURE RESISTANCE (MR)

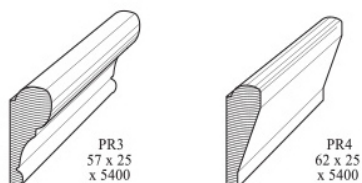

DIMENSIONS (MM)	LENGTHS (M)	L/M
57 x 25 - PR3	2.7 / 5.4	\$ 6.00
62 x 25 - PR4	2.7 / 5.4	\$ 6.00

## Picture Rails

MEDIUM DENSITY FIBREBOARD (MDF), MOISTURE RESISTANCE (MR)

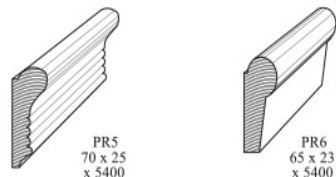

DIMENSIONS (MM)	LENGTHS (M)	L/M
70 x 25 - PR5	2.7 / 5.4	\$ 6.00
65 x 23 - PR6	2.7 / 5.4	\$ 6.00

## Dado Rail

MEDIUM DENSITY FIBREBOARD (MDF), MOISTURE RESISTANCE (MR)

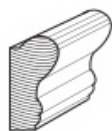

DM13  
40 x 18  
x 5400

DIMENSIONS (MM)	LENGTHS (M)	L/M
40 x 18 - DM13	2.7 / 5.4	\$ 2.40

# SUBLACO RESTORATION

EST. 1981

## Stringers

MEDIUM DENSITY FIBREBOARD (MDF), MOISTURE RESISTANCE (MR)

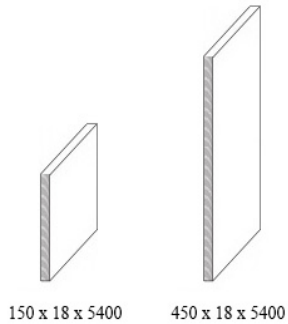

DIMENSIONS (MM)	LENGTHS (M)	L/M
450 x 18	5.4	\$ 16.90
150 x 18	5.4	\$ 6.80

## Panels

MEDIUM DENSITY FIBREBOARD (MDF), MOISTURE RESISTANCE (MR)



5400 x 1200



2400 x 1200

DIMENSIONS (MM)	PER SHEET
5400 x 1200 x 32	\$ 322.00
5400 x 1200 x 25	\$ 253.00
5400 x 1200 x 18	\$ 147.00
5400 x 1200 x 12	\$ 129.00
2400 x 1200 x 32	\$ 143.00
2400 x 1200 x 25	\$ 110.00
2400 x 1200 x 18	\$ 64.00