

SUBIACO RESTORATION

EST. 1981

Mouldings

RETAIL PRICE LIST

Prices inc. GST

SUPPLYING WA BUILDINGS SINCE 1981

Timber | Structural Timber | Decking | Mouldings | Flooring | Doors, Windows & Joinery
Heating | Architectural Hardware | Lighting & Ceilings | Cooking | Bathroom | Homewares

SUBLACO RESTORATION

EST. 1981

Skirtings

MEDIUM DENSITY FIBREBOARD (MDF), MOISTURE RESISTANCE (MR)

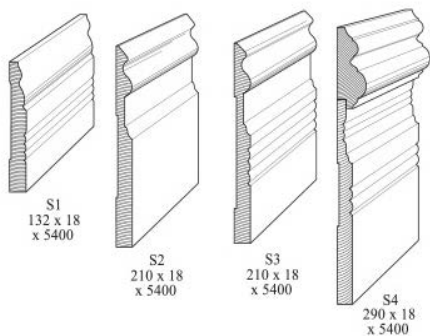

| DIMENSIONS (MM) | LENGTHS (M) | L/M |
|------------------------|-------------|----------|
| 132 x 18 - S1 (Primed) | 2.7 / 5.4 | \$ 8.16 |
| 210 x 18 - S2 (Primed) | 2.7 / 5.4 | \$ 10.98 |
| 210 x 18 - S3 | 2.7 / 5.4 | \$ 10.98 |
| 290 x 18 - S4 | 2.7 / 5.4 | \$ 19.95 |

Skirtings

MEDIUM DENSITY FIBREBOARD (MDF), MOISTURE RESISTANCE (MR)

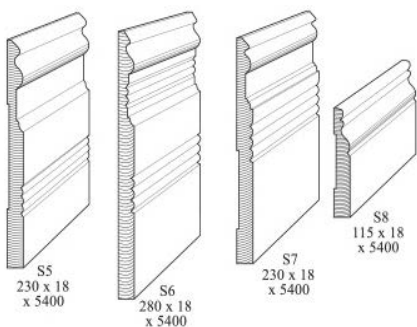

| DIMENSIONS (MM) | LENGTHS (M) | L/M |
|------------------------|-------------|----------|
| 230 x 18 - S5 (Primed) | 2.7 / 5.4 | \$ 12.28 |
| 280 x 18 - S6 | 2.7 / 5.4 | \$ 16.33 |
| 230 x 18 - S7 | 2.7 / 5.4 | \$ 12.28 |
| 115 x 18 - S8 (Primed) | 2.7 / 5.4 | \$ 6.84 |

Skirtings

MEDIUM DENSITY FIBREBOARD (MDF), MOISTURE RESISTANCE (MR)

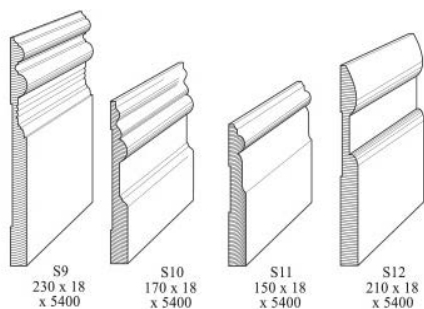

| DIMENSIONS (MM) | LENGTHS (M) | L/M |
|-------------------------|-------------|----------|
| 230 x 18 - S9 | 2.7 / 5.4 | \$ 11.60 |
| 170 x 18 - S10 (Primed) | 2.7 / 5.4 | \$ 8.49 |
| 150 x 18 - S11 (Primed) | 2.7 / 5.4 | \$ 8.76 |
| 210 x 18 - S12 (Primed) | 2.7 / 5.4 | \$ 10.98 |

SUBLACO RESTORATION

EST. 1981

Skirtings

MEDIUM DENSITY FIBREBOARD (MDF), MOISTURE RESISTANCE (MR)

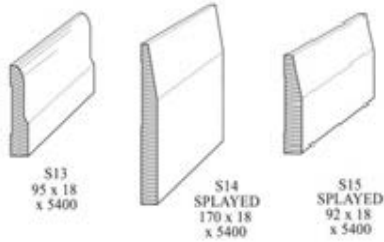

| DIMENSIONS (MM) | LENGTHS (M) | L/M |
|---------------------------------|-------------|---------|
| 95 x 18 - S13 (Primed) | 2.7 / 5.4 | \$ 5.59 |
| 170 x 18 - S14 Splayed (Primed) | 2.7 / 5.4 | \$ 8.49 |
| 92 x 18 - S15 Splayed (Primed) | 2.7 / 5.4 | \$ 5.59 |

WA Colonial Skirtings

MEDIUM DENSITY FIBREBOARD (MDF), MOISTURE RESISTANCE (MR)

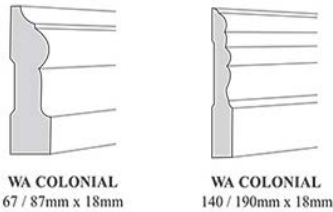

| DIMENSIONS (MM) | LENGTHS (M) | L/M |
|-------------------|-------------|---------|
| 67 x 18 (Primed) | 2.7 / 5.4 | \$ 2.64 |
| 87 x 18 (Primed) | 2.7 / 5.4 | \$ 3.54 |
| 140 x 18 (Primed) | 2.7 / 5.4 | \$ 5.96 |
| 190 x 18 (Primed) | 2.7 / 5.4 | \$ 9.37 |

Single Bullnosed Skirtings

MEDIUM DENSITY FIBREBOARD (MDF), MOISTURE RESISTANCE (MR)

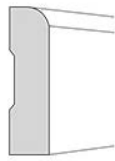

67 / 92 x 18mm

| DIMENSIONS (MM) | LENGTHS (M) | L/M |
|------------------|-------------|---------|
| 67 x 18 (Primed) | 2.7 / 5.4 | \$ 2.64 |
| 92 x 18 (Primed) | 2.7 / 5.4 | \$ 3.54 |

Half Splayed Skirtings

MEDIUM DENSITY FIBREBOARD (MDF), MOISTURE RESISTANCE (MR)

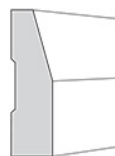

HALF SPLAYED
67/92/140 x 18mm

| DIMENSIONS (MM) | LENGTHS (M) | L/M |
|-------------------|-------------|---------|
| 67 x 18 (Primed) | 2.7 / 5.4 | \$ 2.64 |
| 92 x 18 (Primed) | 2.7 / 5.4 | \$ 3.54 |
| 140 x 18 (Primed) | 2.7 / 5.4 | \$ 5.96 |

SUBLACO RESTORATION

EST. 1981

Lambs Tounge Skirtings

MEDIUM DENSITY FIBREBOARD (MDF), MOISTURE RESISTANCE (MR)

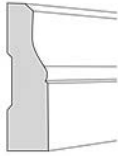

LAMBS TONGUE
67 / 92 / 140 x 18mm

| DIMENSIONS (MM) | LENGTHS (M) | L/M |
|-------------------|-------------|---------|
| 67 x 18 (Primed) | 2.7 / 5.4 | \$ 2.64 |
| 90 x 18 (Primed) | 2.7 / 5.4 | \$ 3.54 |
| 140 x 18 (Primed) | 2.7 / 5.4 | \$ 5.96 |

WA Federation Skirtings

MEDIUM DENSITY FIBREBOARD (MDF), MOISTURE RESISTANCE (MR)

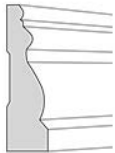

WA FEDERATION
65 / 80 / 125 x 18mm

| DIMENSIONS (MM) | LENGTHS (M) | L/M |
|-------------------|-------------|---------|
| 65 x 18 (Primed) | 2.7 / 5.4 | \$ 2.64 |
| 80 x 18 (Primed) | 2.7 / 5.4 | \$ 3.54 |
| 125 x 18 (Primed) | 2.7 / 5.4 | \$ 5.96 |

Skirting Blocks

MEDIUM DENSITY FIBREBOARD (MDF), MOISTURE RESISTANCE (MR)

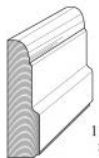

SB1
115 x 32
x 5400

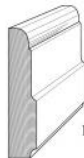

SB2
140 x 32
x 5400

| DIMENSIONS (MM) | LENGTHS (M) | L/M |
|-----------------|-------------|----------|
| 115 x 32 - SB1 | 2.7 / 5.4 | \$ 9.61 |
| 140 x 32 - SB2 | 2.7 / 5.4 | \$ 10.71 |

Skirting Blocks

MEDIUM DENSITY FIBREBOARD (MDF), MOISTURE RESISTANCE (MR)



SB3
115 x 32
x 5400

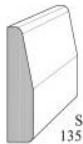

SB4
135 x 32
x 5400



SB5
80 x 25
x 5400

| DIMENSIONS (MM) | LENGTHS (M) | L/M |
|-----------------|-------------|----------|
| 115 x 32 - SB3 | 2.7 / 5.4 | \$ 9.61 |
| 135 x 32 - SB4 | 2.7 / 5.4 | \$ 10.71 |
| 80 x 25 - SB5 | 2.7 / 5.4 | \$ 5.89 |

SUBLACO RESTORATION

EST. 1981

Jarrah Colonial Skirting and Architraves



| DIMENSIONS (MM) | LENGTHS (M) | L/M |
|-----------------|----------------|----------|
| 125 x 19 | Random Lengths | \$ 23.00 |
| 80 x 19 | Random Lengths | \$ 14.10 |
| 65 x 19 | Random Lengths | \$ 10.40 |

Jarrah Splayed Skirting and Architraves

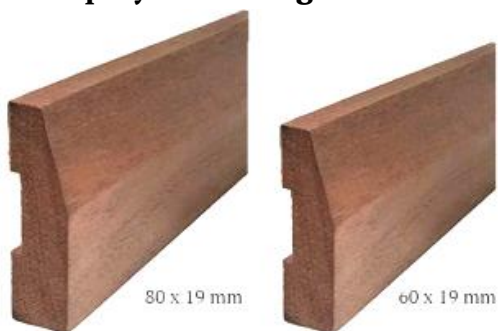

| DIMENSIONS (MM) | LENGTHS (M) | L/M |
|-----------------|----------------|----------|
| 80 x 19 | Random Lengths | \$ 14.10 |
| 60 x 19 | Random Lengths | \$ 9.70 |

Jarrah Single Bullnosed Skirting and Architraves

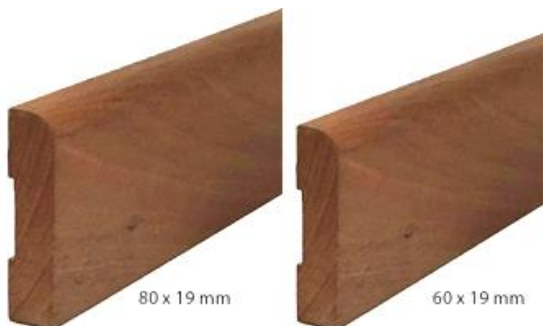

| DIMENSIONS (MM) | LENGTHS (M) | L/M |
|-----------------|----------------|----------|
| 80 x 19 | Random Lengths | \$ 14.10 |
| 60 x 19 | Random Lengths | \$ 9.70 |

Jarrah Double Bullnosed Architrave



| DIMENSIONS (MM) | LENGTHS (M) | L/M |
|-----------------|----------------|----------|
| 80 x 19 | Random Lengths | \$ 14.10 |
| 60 x 19 | Random Lengths | \$ 9.70 |
| 40 x 19 | Random Lengths | \$ 3.90 |

SUBLACO RESTORATION

EST. 1981

Architraves

MEDIUM DENSITY FIBREBOARD (MDF), MOISTURE RESISTANCE (MR)

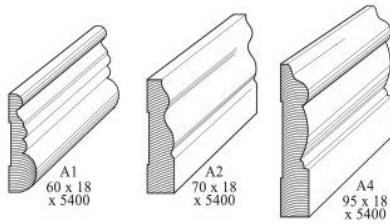

| DIMENSIONS (MM) | LENGTHS (M) | L/M |
|-----------------------|-------------|---------|
| 60 x 18 - A1 | 2.7 / 5.4 | \$ 3.68 |
| 70 x 18 - A2 | 2.7 / 5.4 | \$ 3.94 |
| 95 x 18 - A4 (Primed) | 2.7 / 5.4 | \$ 5.59 |

Architraves

MEDIUM DENSITY FIBREBOARD (MDF), MOISTURE RESISTANCE (MR)

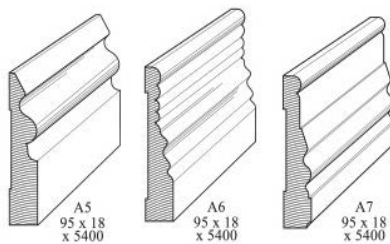

| DIMENSIONS (MM) | LENGTHS (M) | L/M |
|-----------------------|-------------|---------|
| 95 x 18 - A5 | 2.7 / 5.4 | \$ 4.91 |
| 95 x 18 - A6 (Primed) | 2.7 / 5.4 | \$ 5.59 |
| 90 x 18 - A7 (Primed) | 2.7 / 5.4 | \$ 5.59 |

Architraves

MEDIUM DENSITY FIBREBOARD (MDF), MOISTURE RESISTANCE (MR)

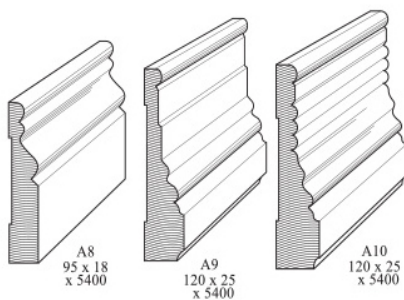

| DIMENSIONS (MM) | LENGTHS (M) | L/M |
|-------------------------|-------------|---------|
| 95 x 18 x - A8 (Primed) | 2.7 / 5.4 | \$ 5.59 |
| 120 x 25 - A9 | 2.7 / 5.4 | \$ 8.03 |
| 120 x 25 - A10 | 2.7 / 5.4 | \$ 8.03 |

Architraves

MEDIUM DENSITY FIBREBOARD (MDF), MOISTURE RESISTANCE (MR)

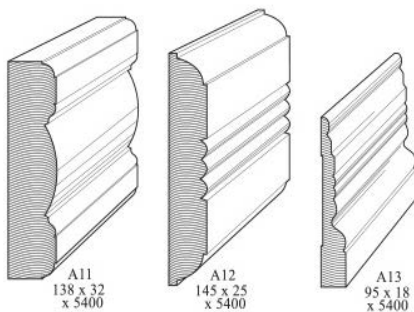

| DIMENSIONS (MM) | LENGTHS (M) | L/M |
|------------------------|-------------|----------|
| 138 x 32 - A11 | 2.7 / 5.4 | \$ 10.71 |
| 145 x 25 - A12 | 2.7 / 5.4 | \$ 9.40 |
| 95 x 18 - A13 (Primed) | 2.7 / 5.4 | \$ 5.59 |

SUBLACO RESTORATION

EST. 1981

Architraves

MEDIUM DENSITY FIBREBOARD (MDF), MOISTURE RESISTANCE (MR)

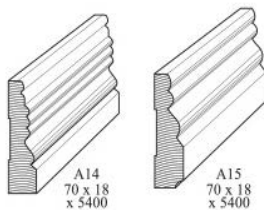

| DIMENSIONS (MM) | LENGTHS (M) | L/M |
|-----------------|-------------|---------|
| 70 x 18 - A14 | 2.7 / 5.4 | \$ 3.94 |
| 70 x 18 - A15 | 2.7 / 5.4 | \$ 3.94 |

WA Colonial Architraves

MEDIUM DENSITY FIBREBOARD (MDF), HIGH MOISTURE RESISTANCE (MR)

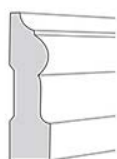

WA COLONIAL
67 / 87mm x 18mm

| DIMENSIONS (MM) | LENGTHS (M) | L/M |
|------------------|-------------|---------|
| 67 x 18 (Primed) | 2.7 / 5.4 | \$ 2.64 |
| 87 x 18 (Primed) | 2.7 / 5.4 | \$ 3.54 |

Double Bullnosed Architraves

MEDIUM DENSITY FIBREBOARD (MDF), MOISTURE RESISTANCE (MR)

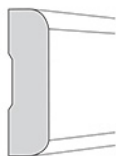

DOUBLE BULLNOSED ARCH
67mm x 18mm

| DIMENSIONS (MM) | LENGTHS (M) | L/M |
|------------------|-------------|---------|
| 42 x 18 (Primed) | 2.7 / 5.4 | \$ 1.98 |
| 67 x 18 (Primed) | 2.7 / 5.4 | \$ 2.64 |

Single Bullnosed Architraves

MEDIUM DENSITY FIBREBOARD (MDF), MOISTURE RESISTANCE (MR)

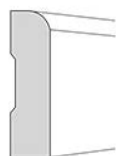

67 / 92 x 18mm

| DIMENSIONS (MM) | LENGTHS (M) | L/M |
|------------------|-------------|---------|
| 67 x 18 (Primed) | 2.7 / 5.4 | \$ 2.64 |
| 92 x 18 (Primed) | 2.7 / 5.4 | \$ 3.54 |

SUBLACO RESTORATION

EST. 1981

Half Splayed Architraves

MEDIUM DENSITY FIBREBOARD (MDF), MOISTURE RESISTANCE (MR)

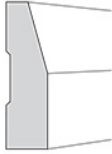

HALF SPLAYED
67/92/140 x 18mm

| DIMENSIONS (MM) | LENGTHS (M) | L/M |
|-------------------|-------------|---------|
| 67 x 18 (Primed) | 2.7 / 5.4 | \$ 2.64 |
| 92 x 18 (Primed) | 2.7 / 5.4 | \$ 3.54 |
| 140 x 18 (Primed) | 2.7 / 5.4 | \$ 5.96 |

Lambs Tounge Architraves

MEDIUM DENSITY FIBREBOARD (MDF), MOISTURE RESISTANCE (MR)

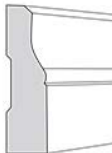

LAMBS TONGUE
67 / 92 x 18mm

| DIMENSIONS (MM) | LENGTHS (M) | L/M |
|------------------|-------------|---------|
| 67 x 18 (Primed) | 2.7 / 5.4 | \$ 2.64 |
| 92 x 18 (Primed) | 2.7 / 5.4 | \$ 3.54 |

WA Federation Architraves

MEDIUM DENSITY FIBREBOARD (MDF), MOISTURE RESISTANCE (MR)

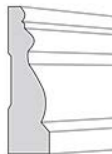

WA FEDERATION
65 / 80 x 18mm

| DIMENSIONS (MM) | LENGTHS (M) | L/M |
|------------------|-------------|---------|
| 65 x 18 (Primed) | 2.7 / 5.4 | \$ 2.64 |
| 80 x 18 (Primed) | 2.7 / 5.4 | \$ 3.54 |

External Architraves & Skirtings

H3 LOSP TREATED PINE

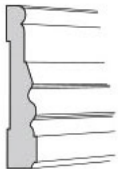

A7
90 x 18

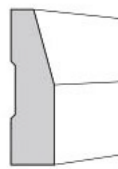

HALF SPLAYED
90 x 18

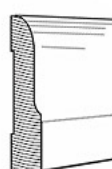

S13
90 x 18

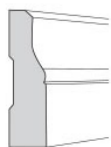

LAMBS TONGUE
90 x 18

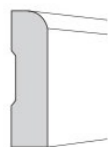

SINGLE BULLNOSED
90 x 18

| DIMENSIONS (MM) | LENGTHS (M) | L/M |
|---------------------------|-------------|---------|
| 90 x 18 - A7 | 2.7 / 5.4 | \$ 8.30 |
| 90 x 18 - Half Splayed | 2.7 / 5.4 | \$ 8.30 |
| 90 x 18 - S13 | 2.7 / 5.4 | \$ 8.30 |
| 90 x 18 - Lambs Tounge | 2.7 / 5.4 | \$ 8.30 |
| 90 x 18 - Single Bullnose | 2.7 / 5.4 | \$ 8.30 |

SUBLACO RESTORATION

EST. 1981

Quads

Jarrah lengths available on request.



QUAD

12 x 12
18 x 18
32 x 32



SQUARE DRESSED

18 x 18

| DIMENSIONS (MM) | LENGTHS (M) | L/M |
|---|-------------|----------|
| 18 x 18 - MDF (Primed) | 2.7 / 5.4 | \$ 1.61 |
| 32 x 32 - MDF | 2.7 / 5.4 | \$ 4.99 |
| 12 x 12 - Pine H3 LOSP (Primed) | 2.7 / 5.4 | \$ 1.40 |
| 18 x 18 - Pine H3 LOSP (Primed) | 2.7 / 5.4 | \$ 1.82 |
| 18 x 18 - Square Dressed Pine H3 (Primed) | 2.7 / 5.4 | \$ 1.82 |
| 12 x 12 - Jarrah | | \$ 4.15 |
| 18 x 18 - Jarrah | | \$ 5.70 |
| 32 x 32 - Jarrah | | \$ 13.15 |

Door Stops

MEDIUM DENSITY FIBREBOARD (MDF), MOISTURE RESISTANCE (MR)



30 x 12
MDF



42 x 12
MDF



40 x 12
Jarrah

| DIMENSIONS (MM) | LENGTHS (M) | L/M |
|------------------------|-------------|---------|
| 30 x 12 - MDF (Primed) | 2.7 / 5.4 | \$ 1.47 |
| 42 x 12 - MDF (Primed) | 2.7 / 5.4 | \$ 1.58 |
| 40 x 12 - Jarrah | 2.1 / 3.0 | \$ 5.50 |

Scotias

MEDIUM DENSITY FIBREBOARD (MDF), MOISTURE RESISTANCE (MR)



| DIMENSIONS (MM) | LENGTHS (M) | L/M |
|------------------------|-------------|----------|
| 42 x 18 - MDF (Primed) | 2.7 / 5.4 | \$ 2.44 |
| 30 x 30 - Jarrah | | \$ 11.15 |

Cornice / Crown Mouldings

MEDIUM DENSITY FIBREBOARD (MDF), MOISTURE RESISTANCE (MR)



C1
93 x 18

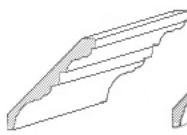

C13
128 x 18

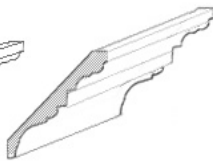

C14
180 x 18

| DIMENSIONS (MM) | LENGTHS (M) | L/M |
|-----------------|-------------|---------|
| 93 x 18 - C1 | 2.7 / 5.4 | \$ 5.70 |
| 128 x 18 - C13 | 2.7 / 5.4 | \$ 7.00 |
| 180 x 18 - C14 | 2.7 / 5.4 | \$ 9.40 |

SUBLACO RESTORATION

EST. 1981

Nosing

MEDIUM DENSITY FIBREBOARD (MDF), MOISTURE RESISTANCE (MR)

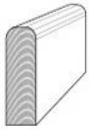

N1
100 x 32

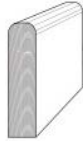

N2
125 x 32

| DIMENSIONS (MM) | LENGTHS (M) | L/M |
|-----------------|-------------|---------|
| 100 x 32 - N1 | 2.7 / 5.4 | \$ 7.60 |
| 125 x 32 - N2 | 2.7 / 5.4 | \$ 9.00 |

Nosing

MEDIUM DENSITY FIBREBOARD (MDF), MOISTURE RESISTANCE (MR)

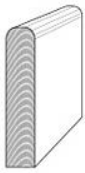

N3
150 x 32



N5
175 x 32

| DIMENSIONS (MM) | LENGTHS (M) | L/M |
|-----------------|-------------|----------|
| 150 x 32 - N3 | 2.7 / 5.4 | \$ 10.45 |
| 175 x 32 - N5 | 2.7 / 5.4 | \$ 11.40 |

Nosing

MEDIUM DENSITY FIBREBOARD (MDF), MOISTURE RESISTANCE (MR)



| DIMENSIONS (MM) | LENGTHS (M) | L/M |
|-------------------|-------------|----------|
| 170 x 25 (Primed) | 2.7 / 5.4 | \$ 14.05 |

Square Dressed

MEDIUM DENSITY FIBREBOARD (MDF), MOISTURE RESISTANCE (MR)



30 x 12



42 x 12

| DIMENSIONS (MM) | LENGTHS (M) | L/M |
|------------------|-------------|---------|
| 30 x 12 (Primed) | 2.7 / 5.4 | \$ 1.47 |
| 42 x 12 (Primed) | 2.7 / 5.4 | \$ 1.58 |

Square Dressed

MEDIUM DENSITY FIBREBOARD (MDF), MOISTURE RESISTANCE (MR)



42 x 18



67 x 18



92 x 18

| DIMENSIONS (MM) | LENGTHS (M) | L/M |
|-------------------|-------------|---------|
| 42 x 18 (Primed) | 2.7 / 5.4 | \$ 1.98 |
| 67 x 18 (Primed) | 2.7 / 5.4 | \$ 2.64 |
| 92 x 18 (Primed) | 2.7 / 5.4 | \$ 3.54 |
| 150 x 18 (Primed) | 2.7 / 5.4 | \$ 5.20 |

SUBLACO RESTORATION

EST. 1981

Picture Rails

MEDIUM DENSITY FIBREBOARD (MDF), MOISTURE RESISTANCE (MR)

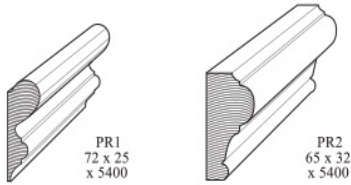

PR1
72 x 25
x 5400

PR2
65 x 32
x 5400

| DIMENSIONS (MM) | LENGTHS (M) | L/M |
|-----------------|-------------|---------|
| 72 x 25 - PR1 | 2.7 / 5.4 | \$ 6.25 |
| 65 x 32 - PR2 | 2.7 / 5.4 | \$ 7.20 |

Picture Rails

MEDIUM DENSITY FIBREBOARD (MDF), MOISTURE RESISTANCE (MR)

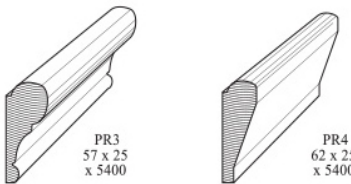

PR3
57 x 25
x 5400

PR4
62 x 25
x 5400

| DIMENSIONS (MM) | LENGTHS (M) | L/M |
|-----------------|-------------|---------|
| 57 x 25 - PR3 | 2.7 / 5.4 | \$ 6.00 |
| 62 x 25 - PR4 | 2.7 / 5.4 | \$ 6.00 |

Picture Rails

MEDIUM DENSITY FIBREBOARD (MDF), MOISTURE RESISTANCE (MR)

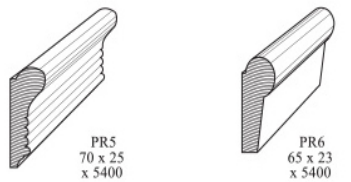

PR5
70 x 25
x 5400

PR6
65 x 23
x 5400

| DIMENSIONS (MM) | LENGTHS (M) | L/M |
|-----------------|-------------|---------|
| 70 x 25 - PR5 | 2.7 / 5.4 | \$ 6.00 |
| 65 x 23 - PR6 | 2.7 / 5.4 | \$ 6.00 |

Dado Rail

MEDIUM DENSITY FIBREBOARD (MDF), MOISTURE RESISTANCE (MR)

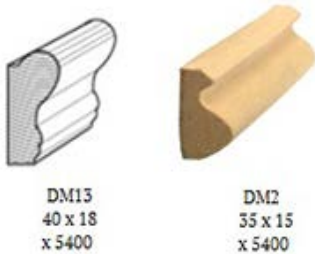

DM13
40 x 18
x 5400

DM2
35 x 15
x 5400

| DIMENSIONS (MM) | LENGTHS (M) | L/M |
|-----------------|-------------|---------|
| 40 x 18 - DM13 | 2.7 / 5.4 | \$ 2.40 |
| 35 x 15 - DM2 | 2.7 / 5.4 | \$ 2.30 |

Bolection Mould

MEDIUM DENSITY FIBREBOARD (MDF), MOISTURE RESISTANCE (MR)



| DIMENSIONS (MM) | LENGTHS (M) | L/M |
|------------------|-------------|---------|
| 42 x 18 (Primed) | 2.7 | \$ 1.72 |

SUBLACO RESTORATION

EST. 1981

Stringers

MEDIUM DENSITY FIBREBOARD (MDF), MOISTURE RESISTANCE (MR)



450 x 18 x 5400

| DIMENSIONS (MM) | LENGTHS (M) | L/M |
|-----------------|-------------|----------|
| 450 x 18 | 2.7 / 5.4 | \$ 16.90 |

Panels

MEDIUM DENSITY FIBREBOARD (MDF), MOISTURE RESISTANCE (MR)



5400 x 1200



2400 x 1200

| DIMENSIONS (MM) | PER SHEET |
|------------------|-----------|
| 5400 x 1200 x 32 | \$ 325.00 |
| 5400 x 1200 x 25 | \$ 260.00 |
| 5400 x 1200 x 18 | \$ 155.45 |
| 5400 x 1200 x 12 | \$ 148.00 |
| 2400 x 1200 x 32 | \$ 146.00 |
| 2400 x 1200 x 25 | \$ 115.60 |
| 2400 x 1200 x 18 | \$ 67.30 |