

# SUBIACO RESTORATION

EST. 1981

# Mouldings

## RETAIL PRICE LIST

Prices inc. GST

SUPPLYING WA BUILDINGS SINCE 1981

Timber | Structural Timber | Decking | Mouldings | Flooring | Doors, Windows & Joinery  
Heating | Architectural Hardware | Lighting & Ceilings | Cooking | Bathroom | Homewares

# SUBIACO RESTORATION

EST. 1981

## Skirtings

MEDIUM DENSITY FIBREBOARD (MDF), MOISTURE RESISTANCE (MR)

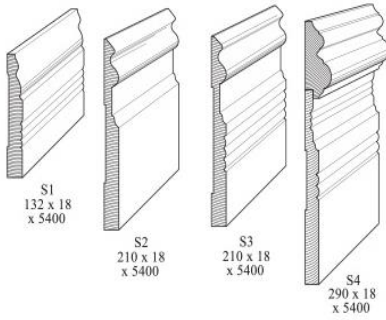

DIMENSIONS (MM)	LENGTHS (M)	L/M
132 x 18 - S1 (Primed)	2.7 / 5.4	\$ 9.64
210 x 18 - S2 (Primed)	2.7 / 5.4	\$ 12.98
210 x 18 - S3	2.7 / 5.4	\$ 14.52
290 x 18 - S4	2.7 / 5.4	\$ 26.38

## Skirtings

MEDIUM DENSITY FIBREBOARD (MDF), MOISTURE RESISTANCE (MR)

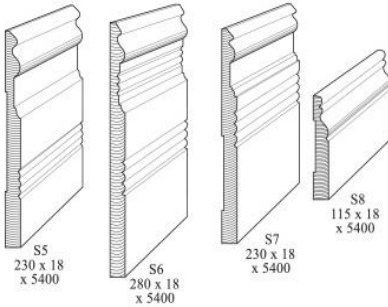

DIMENSIONS (MM)	LENGTHS (M)	L/M
230 x 18 - S5 (Primed)	2.7 / 5.4	\$ 14.52
280 x 18 - S6	2.7 / 5.4	\$ 21.60
230 x 18 - S7	2.7 / 5.4	\$ 16.24
115 x 18 - S8 (Primed)	2.7 / 5.4	\$ 8.10

## Skirtings

MEDIUM DENSITY FIBREBOARD (MDF), MOISTURE RESISTANCE (MR)

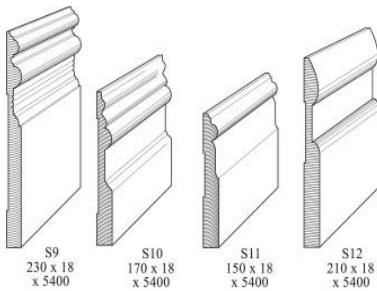

DIMENSIONS (MM)	LENGTHS (M)	L/M
230 x 18 - S9	2.7 / 5.4	\$ 15.34
170 x 18 - S10 (Primed)	2.7 / 5.4	\$ 10.05
150 x 18 - S11 (Primed)	2.7 / 5.4	\$ 10.34
210 x 18 - S12 (Primed)	2.7 / 5.4	\$ 12.98

# SUBIACO RESTORATION

EST. 1981

## Skirtings

MEDIUM DENSITY FIBREBOARD (MDF), MOISTURE RESISTANCE (MR)

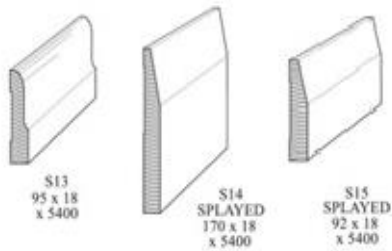

DIMENSIONS (MM)	LENGTHS (M)	L/M
95 x 18 - S13 (Primed)	2.7 / 5.4	\$ 6.60
170 x 18 - S14 Splayed (Primed)	2.7 / 5.4	\$ 10.05
92 x 18 - S15 Splayed (Primed) **	2.7 / 5.4	\$ 6.60
92 x 18 - S15 Splayed	2.7 / 5.4	\$ 6.60

\*\* Currently unavailable

## WA Colonial Skirtings

MEDIUM DENSITY FIBREBOARD (MDF), MOISTURE RESISTANCE (MR)

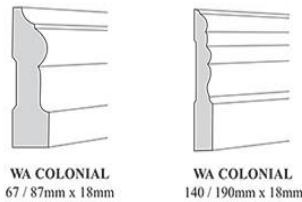

DIMENSIONS (MM)	LENGTHS (M)	L/M
67 x 18 (Primed)	2.7 / 5.4	\$ 3.10
87 x 18 (Primed)	2.7 / 5.4	\$ 4.22
140 x 18 (Primed)	2.7 / 5.4	\$ 6.86
190 x 18 (Primed)	2.7 / 5.4	\$ 11.02

## Single Bullnosed Skirtings

MEDIUM DENSITY FIBREBOARD (MDF), MOISTURE RESISTANCE (MR)

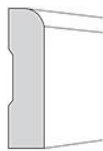

67 / 92 x 18mm

DIMENSIONS (MM)	LENGTHS (M)	L/M
67 x 18 (Primed)	2.7 / 5.4	\$ 3.10
92 x 18 (Primed)	2.7 / 5.4	\$ 4.22

## Half Splayed Skirtings

MEDIUM DENSITY FIBREBOARD (MDF), MOISTURE RESISTANCE (MR)

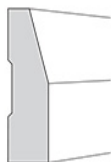

HALF SPLAYED  
67/92/140 x 18mm

DIMENSIONS (MM)	LENGTHS (M)	L/M
67 x 18 (Primed)	2.7 / 5.4	\$ 3.10
92 x 18 (Primed)	2.7 / 5.4	\$ 4.22
140 x 18 (Primed)	2.7 / 5.4	\$ 6.86

# SUBIACO RESTORATION

EST. 1981

## Lambs Tounge Skirtings

MEDIUM DENSITY FIBREBOARD (MDF), MOISTURE RESISTANCE (MR)

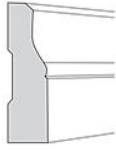

LAMBS TONGUE  
67 / 92 / 140 x 18mm

DIMENSIONS (MM)	LENGTHS (M)	L/M
67 x 18 (Primed)	2.7 / 5.4	\$ 3.10
92 x 18 (Primed)	2.7 / 5.4	\$ 4.22
140 x 18 (Primed)	2.7 / 5.4	\$ 6.86

## WA Federation Skirtings

MEDIUM DENSITY FIBREBOARD (MDF), MOISTURE RESISTANCE (MR)



WA FEDERATION  
65 / 80 / 125 x 18mm

DIMENSIONS (MM)	LENGTHS (M)	L/M
65 x 18 (Primed)	2.7 / 5.4	\$ 3.10
80 x 18 (Primed)	2.7 / 5.4	\$ 4.22
125 x 18 (Primed)	2.7 / 5.4	\$ 6.86

## Cornice / Crown Mouldings

MEDIUM DENSITY FIBREBOARD (MDF), MOISTURE RESISTANCE (MR)

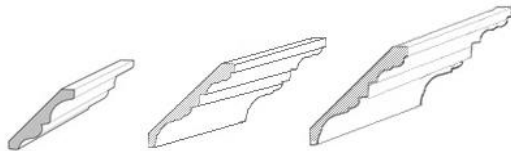

C1  
93 x 18

C13  
128 x 18

C14  
180 x 18

DIMENSIONS (MM)	LENGTHS (M)	L/M
93 x 18 - C1	2.7 / 5.4	\$ 7.54
128 x 18 - C13	2.7 / 5.4	\$ 9.26
180 x 18 - C14	2.7 / 5.4	\$ 12.43

# SUBIACO RESTORATION

EST. 1981

## Jarrah Colonial Skirting and Architraves



DIMENSIONS (MM)	LENGTHS (M)	L/M
65 x 19	Random Lengths	\$ 10.40
80 x 19	Random Lengths	\$ 14.10
125 x 19	Random Lengths	\$ 23.00

## Jarrah Splayed Skirting and Architraves

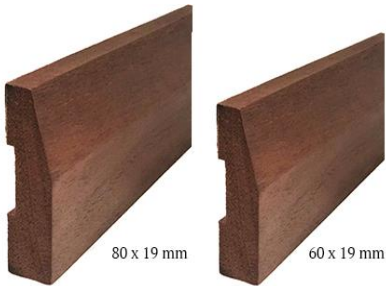

DIMENSIONS (MM)	LENGTHS (M)	L/M
60 x 19	Random Lengths	\$ 9.70
80 x 19	Random Lengths	\$ 14.10

## Jarrah Single Bullnosed Skirting and Architraves

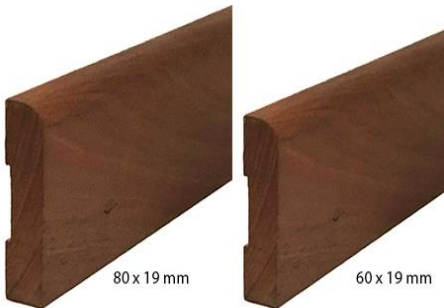

DIMENSIONS (MM)	LENGTHS (M)	L/M
60 x 19	Random Lengths	\$ 9.70
80 x 19	Random Lengths	\$ 14.10

## Jarrah Double Bullnosed Architrave

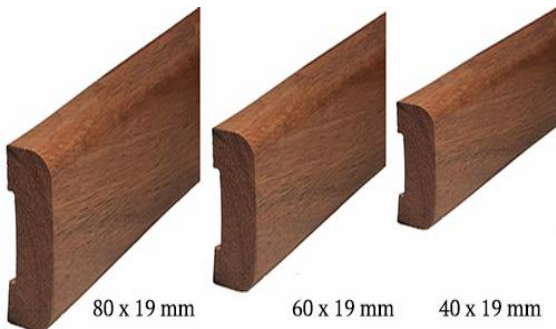

DIMENSIONS (MM)	LENGTHS (M)	L/M
40 x 19	Random Lengths	\$ 3.90
60 x 19	Random Lengths	\$ 9.70
80 x 19	Random Lengths	\$ 14.10

# SUBIACO RESTORATION

EST. 1981

## Architraves

MEDIUM DENSITY FIBREBOARD (MDF), MOISTURE RESISTANCE (MR)

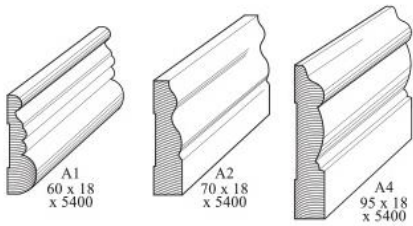

DIMENSIONS (MM)	LENGTHS (M)	L/M
60 x 18 - A1	2.7 / 5.4	\$ 4.87
70 X 18 - A2	2.7 / 5.4	\$ 5.21
95 X 18 - A4 (Primed)	2.7 / 5.4	\$ 6.60

## Architraves

MEDIUM DENSITY FIBREBOARD (MDF), MOISTURE RESISTANCE (MR)

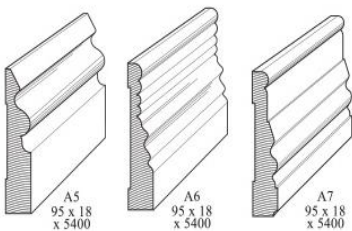

DIMENSIONS (MM)	LENGTHS (M)	L/M
95 x 18 - A5	2.7 / 5.4	\$ 6.49
95 x 18 - A6 (Primed)	2.7 / 5.4	\$ 6.60
95 x 18 - A7 (Primed)	2.7 / 5.4	\$ 6.60

## Architraves

MEDIUM DENSITY FIBREBOARD (MDF), MOISTURE RESISTANCE (MR)

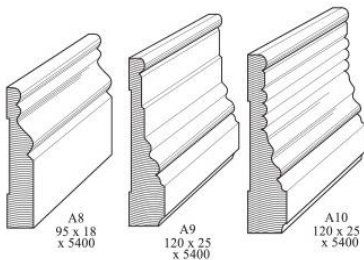

DIMENSIONS (MM)	LENGTHS (M)	L/M
95 x 18 x - A8 (Primed)	2.7 / 5.4	\$ 6.60
120 x 25 - A9	2.7 / 5.4	\$ 10.62
120 x 25 - A10	2.7 / 5.4	\$ 10.62

## Architraves

MEDIUM DENSITY FIBREBOARD (MDF), MOISTURE RESISTANCE (MR)

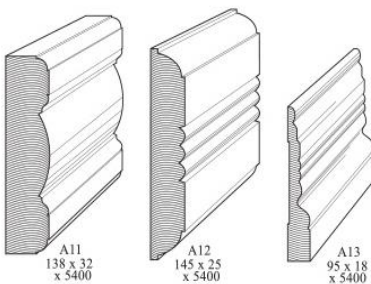

DIMENSIONS (MM)	LENGTHS (M)	L/M
138 x 32 - A11	2.7 / 5.4	\$ 14.16
145 x 25 - A12	2.7 / 5.4	\$ 12.43
95 x 18 - A13 (Primed)	2.7 / 5.4	\$ 6.60

# SUBIACO RESTORATION

EST. 1981

## Architraves

MEDIUM DENSITY FIBREBOARD (MDF), MOISTURE RESISTANCE (MR)

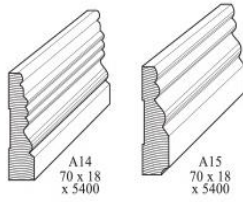

DIMENSIONS (MM)	LENGTHS (M)	L/M
70 x 18 - A14	2.7 / 5.4	\$ 5.21
70 x 18 - A15	2.7 / 5.4	\$ 5.21

## WA Colonial Architraves

MEDIUM DENSITY FIBREBOARD (MDF), HIGH MOISTURE RESISTANCE (MR)

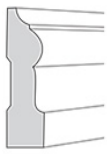

WA COLONIAL  
67 / 87mm x 18mm

DIMENSIONS (MM)	LENGTHS (M)	L/M
67 x 18 (Primed)	2.7 / 5.4	\$ 3.10
87 x 18 (Primed)	2.7 / 5.4	\$ 4.22

## Double Bullnosed Architraves

MEDIUM DENSITY FIBREBOARD (MDF), MOISTURE RESISTANCE (MR)

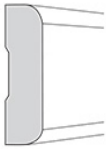

DOUBLE BULLNOSED ARCH  
67mm x 18mm

DIMENSIONS (MM)	LENGTHS (M)	L/M
42 x 18 (Primed)	2.7 / 5.4	\$ 2.63
67 x 18 (Primed)	2.7 / 5.4	\$ 3.10

## Single Bullnosed Architraves

MEDIUM DENSITY FIBREBOARD (MDF), MOISTURE RESISTANCE (MR)

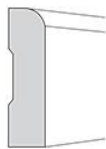

67 / 92 x 18mm

DIMENSIONS (MM)	LENGTHS (M)	L/M
67 x 18 (Primed)	2.7 / 5.4	\$ 3.10
92 x 18 (Primed)	2.7 / 5.4	\$ 4.22

# SUBIACO RESTORATION

EST. 1981

## Half Splayed Architraves

MEDIUM DENSITY FIBREBOARD (MDF), MOISTURE RESISTANCE (MR)

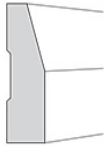

HALF SPLAYED  
67/92/140 x 18mm

DIMENSIONS (MM)	LENGTHS (M)	L/M
67 x 18 (Primed)	2.7 / 5.4	\$ 3.49
92 x 18 (Primed)	2.7 / 5.4	\$ 4.68
140 x 18 (Primed)	2.7 / 5.4	\$ 7.89

## Lambs Tounge Architraves

MEDIUM DENSITY FIBREBOARD (MDF), MOISTURE RESISTANCE (MR)



LAMBS TONGUE  
67 / 92 x 18mm

DIMENSIONS (MM)	LENGTHS (M)	L/M
67 x 18 (Primed)	2.7 / 5.4	\$ 3.49
92 x 18 (Primed)	2.7 / 5.4	\$ 4.68

## WA Federation Architraves

MEDIUM DENSITY FIBREBOARD (MDF), MOISTURE RESISTANCE (MR)



WA FEDERATION  
65 / 80 x 18mm

DIMENSIONS (MM)	LENGTHS (M)	L/M
65 x 18 (Primed)	2.7 / 5.4	\$ 3.49
80 x 18 (Primed)	2.7 / 5.4	\$ 4.68

## Design Pine

### External Architraves & Skirtings

H3 LOSP TREATED PINE

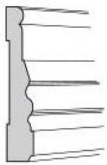

A7  
90 x 18

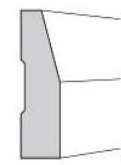

HALF SPLAYED  
90 x 18

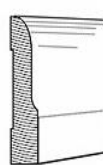

S13  
90 x 18

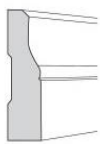

LAMBS TONGUE  
90 x 18

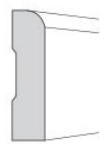

SINGLE BULLNOSED  
90 x 18

DIMENSIONS (MM)	LENGTHS (M)	L/M
90 x 18 - A7 (Primed)	2.7 / 5.4	\$ 9.74
90 x 18 - Half Splayed (Primed)	2.7 / 5.4	\$ 9.74
90 x 18 - S13 (Primed)	2.7 / 5.4	\$ 9.74
90 x 18 - Lambs Tounge (Primed)	2.7 / 5.4	\$ 9.74
90 x 18 - Single Bullnose (Primed)	2.7 / 5.4	\$ 9.74



# SUBIACO RESTORATION

EST. 1981

## Finishing Details

### Quads

Jarrah lengths available on request.



QUAD

12 x 12  
18 x 18  
32 x 32



SQUARE DRESSED

18 x 18

DIMENSIONS (MM)	LENGTHS (M)	L/M
18 x 18 - MDF (Primed)	2.7 / 5.4	\$ 2.13
32 x 32 - MDF	2.7 / 5.4	\$ 5.74
11 x 11 - Pine H3 LOSP (Primed)	2.7 / 5.4	\$ 1.98
18 x 18 - Pine H3 LOSP (Primed)	2.7 / 5.4	\$ 2.10
18 x 18 - Square Dressed Pine H3 (Primed)	2.7 / 5.4	\$ 2.10
12 x 12 - Jarrah		\$ 4.15
18 x 18 - Jarrah		\$ 5.70
32 x 32 - Jarrah		\$ 13.15

### Door Stops

MEDIUM DENSITY FIBREBOARD (MDF), MOISTURE RESISTANCE (MR)



30 x 12  
MDF



42 x 12  
MDF



40 x 12  
Jarrah

DIMENSIONS (MM)	LENGTHS (M)	L/M
30 x 12 - MDF (Primed)	2.7 / 5.4	\$ 1.69
42 x 12 - MDF (Primed)	2.7 / 5.4	\$ 1.87
40 x 12 - Jarrah	2.1 / 3.0	\$ 5.50

### Scotias

MEDIUM DENSITY FIBREBOARD (MDF), MOISTURE RESISTANCE (MR)



DIMENSIONS (MM)	LENGTHS (M)	L/M
42 x 18 - MDF (Primed)	2.7 / 5.4	\$ 3.01
30 x 30 - Jarrah		\$ 11.15

### Skirting Blocks

MEDIUM DENSITY FIBREBOARD (MDF), MOISTURE RESISTANCE (MR)

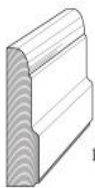

SB1  
115 x 32  
x 5400

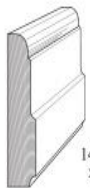

SB2  
140 x 32  
x 5400

DIMENSIONS (MM)	LENGTHS (M)	L/M
115 x 32 - SB1	2.7 / 5.4	\$ 12.71
140 x 32 - SB2	2.7 / 5.4	\$ 14.16

### Skirting Blocks

MEDIUM DENSITY FIBREBOARD (MDF), MOISTURE RESISTANCE (MR)



SB3  
115 x 32  
x 5400



SB4  
135 x 32  
x 5400

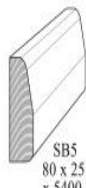

SB5  
80 x 25  
x 5400

DIMENSIONS (MM)	LENGTHS (M)	L/M
115 x 32 - SB3	2.7 / 5.4	\$ 12.71
135 x 32 - SB4	2.7 / 5.4	\$ 14.16
80 x 25 - SB5	2.7 / 5.4	\$ 7.79

# SUBIACO RESTORATION

EST. 1981

## Nosing

MEDIUM DENSITY FIBREBOARD (MDF), MOISTURE RESISTANCE (MR)

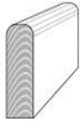

N1  
100 x 32



N2  
125 x 32

DIMENSIONS (MM)	LENGTHS (M)	L/M
100 x 32 - N1	2.7 / 5.4	\$ 10.05
125 x 32 - N2	2.7 / 5.4	\$ 11.90

## Nosing

MEDIUM DENSITY FIBREBOARD (MDF), MOISTURE RESISTANCE (MR)

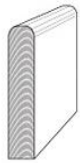

N3  
150 x 32



N5  
175 x 32

DIMENSIONS (MM)	LENGTHS (M)	L/M
150 x 32 - N3	2.7 / 5.4	\$ 13.82
175 x 32 - N5	2.7 / 5.4	\$ 15.08

## Square Dressed

MEDIUM DENSITY FIBREBOARD (MDF), MOISTURE RESISTANCE (MR)



30 x 12



42 x 12



42 x 18



67 x 18



92 x 18

DIMENSIONS (MM)	LENGTHS (M)	L/M
30 x 12 (Primed)	2.7 / 5.4	\$ 1.69
42 x 12 (Primed)	2.7 / 5.4	\$ 1.87
42 x 18 (Primed)	2.7 / 5.4	\$ 2.42
67 x 18 (Primed)	2.7 / 5.4	\$ 3.10
92 x 18 (Primed)	2.7 / 5.4	\$ 4.22
150 x 18 (Primed)	2.7 / 5.4	\$ 10.34

# SUBIACO RESTORATION

EST. 1981

## MDF Railing

MEDIUM DENSITY FIBREBOARD (MDF), MOISTURE RESISTANCE (MR)

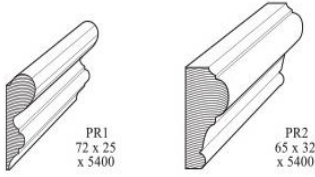

DIMENSIONS (MM)	LENGTHS (M)	L/M
72 x 25 - PR1	2.7 / 5.4	\$ 8.27
65 x 32 - PR2	2.7 / 5.4	\$ 9.52

## MDF Railing

MEDIUM DENSITY FIBREBOARD (MDF), MOISTURE RESISTANCE (MR)

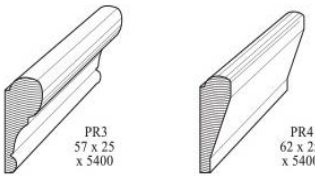

DIMENSIONS (MM)	LENGTHS (M)	L/M
57 x 25 - PR3	2.7 / 5.4	\$ 7.94
62 x 25 - PR4	2.7 / 5.4	\$ 7.94

## Picture Rails

MEDIUM DENSITY FIBREBOARD (MDF), MOISTURE RESISTANCE (MR)

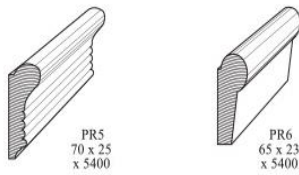

DIMENSIONS (MM)	LENGTHS (M)	L/M
70 x 25 - PR5	2.7 / 5.4	\$ 7.94
65 x 23 - PR6	2.7 / 5.4	\$ 7.94

## Dado Rail

MEDIUM DENSITY FIBREBOARD (MDF), MOISTURE RESISTANCE (MR)

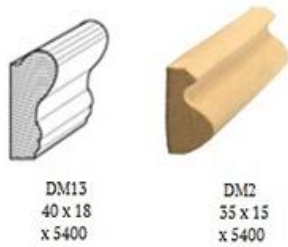

DIMENSIONS (MM)	LENGTHS (M)	L/M
40 x 18 - DM13	2.7 / 5.4	\$ 3.17
35 x 15 - DM2	2.7 / 5.4	\$ 3.04

## Bolection Mould

MEDIUM DENSITY FIBREBOARD (MDF), MOISTURE RESISTANCE (MR)



DIMENSIONS (MM)	LENGTHS (M)	L/M
42 x 18 (Primed)	2.7	\$ 1.83