

Mouldings

RETAIL PRICE LIST

Prices inc. GST

SUBLACO RESTORATION

EST. 1981

Skirtings

MEDIUM DENSITY FIBREBOARD (MDF), MOISTURE RESISTANCE (MR)

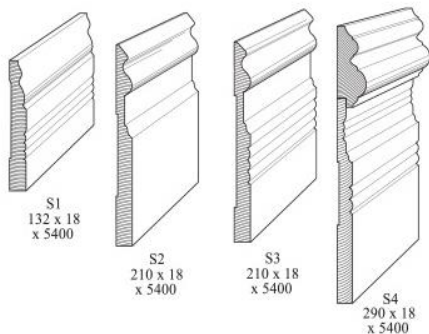

DIMENSIONS (MM)	LENGTHS (M)	L/M
132 x 18 - S1 (Primed)	2.7 / 5.4	\$ 8.16
210 x 18 - S2 (Primed)	2.7 / 5.4	\$ 10.98
210 x 18 - S3	2.7 / 5.4	\$ 10.98
290 x 18 - S4	2.7 / 5.4	\$ 19.95

Skirtings

MEDIUM DENSITY FIBREBOARD (MDF), MOISTURE RESISTANCE (MR)

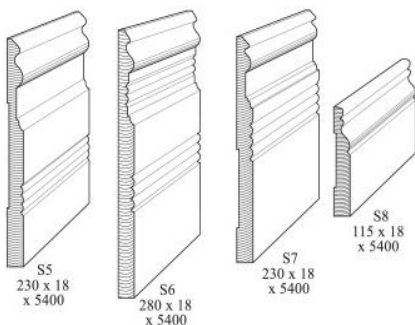

DIMENSIONS (MM)	LENGTHS (M)	L/M
230 x 18 - S5 (Primed)	2.7 / 5.4	\$ 12.28
280 x 18 - S6	2.7 / 5.4	\$ 16.33
230 x 18 - S7	2.7 / 5.4	\$ 12.28
115 x 18 - S8 (Primed)	2.7 / 5.4	\$ 6.84

Skirtings

MEDIUM DENSITY FIBREBOARD (MDF), MOISTURE RESISTANCE (MR)

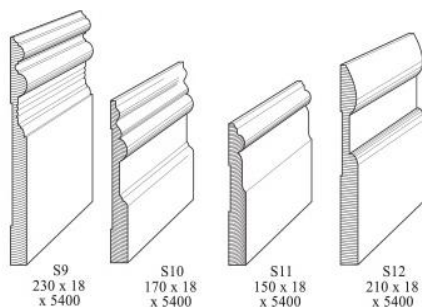

DIMENSIONS (MM)	LENGTHS (M)	L/M
230 x 18 - S9	2.7 / 5.4	\$ 11.60
170 x 18 - S10 (Primed)	2.7 / 5.4	\$ 8.49
150 x 18 - S11 (Primed)	2.7 / 5.4	\$ 8.76
210 x 18 - S12 (Primed)	2.7 / 5.4	\$ 10.98

SUBLACO RESTORATION

EST. 1981

Skirtings

MEDIUM DENSITY FIBREBOARD (MDF), MOISTURE RESISTANCE (MR)

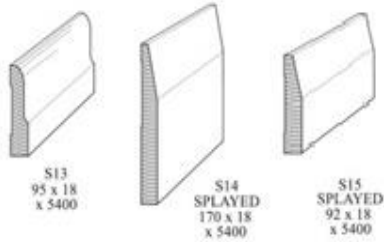

DIMENSIONS (MM)	LENGTHS (M)	L/M
95 x 18 - S13 (Primed)	2.7 / 5.4	\$ 5.59
170 x 18 - S14 Splayed (Primed)	2.7 / 5.4	\$ 8.49
92 x 18 - S15 Splayed (Primed)	2.7 / 5.4	\$ 5.59

WA Colonial Skirtings

MEDIUM DENSITY FIBREBOARD (MDF), MOISTURE RESISTANCE (MR)

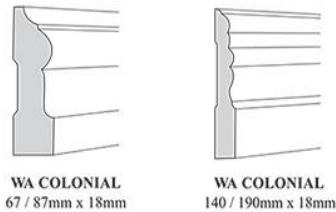

DIMENSIONS (MM)	LENGTHS (M)	L/M
67 x 18 (Primed)	2.7 / 5.4	\$ 2.64
87 x 18 (Primed)	2.7 / 5.4	\$ 3.54
140 x 18 (Primed)	2.7 / 5.4	\$ 5.96
190 x 18 (Primed)	2.7 / 5.4	\$ 9.37

Single Bullnosed Skirtings

MEDIUM DENSITY FIBREBOARD (MDF), MOISTURE RESISTANCE (MR)

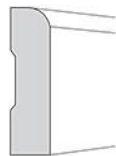

67 / 92 x 18mm

DIMENSIONS (MM)	LENGTHS (M)	L/M
67 x 18 (Primed)	2.7 / 5.4	\$ 2.64
92 x 18 (Primed)	2.7 / 5.4	\$ 3.54

Half Splayed Skirtings

MEDIUM DENSITY FIBREBOARD (MDF), MOISTURE RESISTANCE (MR)



HALF SPLAYED
67/92/140 x 18mm

DIMENSIONS (MM)	LENGTHS (M)	L/M
67 x 18 (Primed)	2.7 / 5.4	\$ 2.64
92 x 18 (Primed)	2.7 / 5.4	\$ 3.54
140 x 18 (Primed)	2.7 / 5.4	\$ 5.96

SUBLACO RESTORATION

EST. 1981

Lambs Tounge Skirtings

MEDIUM DENSITY FIBREBOARD (MDF), MOISTURE RESISTANCE (MR)

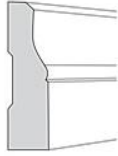

LAMBS TONGUE
67 / 92 / 140 x 18mm

DIMENSIONS (MM)	LENGTHS (M)	L/M
67 x 18 (Primed)	2.7 / 5.4	\$ 2.64
92 x 18 (Primed)	2.7 / 5.4	\$ 3.54
140 x 18 (Primed)	2.7 / 5.4	\$ 5.96

WA Federation Skirtings

MEDIUM DENSITY FIBREBOARD (MDF), MOISTURE RESISTANCE (MR)

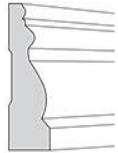

WA FEDERATION
65 / 80 / 125 x 18mm

DIMENSIONS (MM)	LENGTHS (M)	L/M
65 x 18 (Primed)	2.7 / 5.4	\$ 2.64
80 x 18 (Primed)	2.7 / 5.4	\$ 3.54
125 x 18 (Primed)	2.7 / 5.4	\$ 5.96

Skirting Blocks

MEDIUM DENSITY FIBREBOARD (MDF), MOISTURE RESISTANCE (MR)

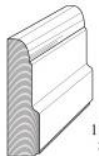

SB1
115 x 32
x 5400

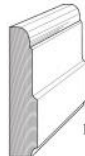

SB2
140 x 32
x 5400

DIMENSIONS (MM)	LENGTHS (M)	L/M
115 x 32 - SB1	2.7 / 5.4	\$ 9.61
140 x 32 - SB2	2.7 / 5.4	\$ 10.71

Skirting Blocks

MEDIUM DENSITY FIBREBOARD (MDF), MOISTURE RESISTANCE (MR)



SB3
115 x 32
x 5400

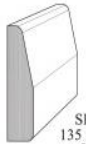

SB4
135 x 32
x 5400



SB5
80 x 25
x 5400

DIMENSIONS (MM)	LENGTHS (M)	L/M
115 x 32 - SB3	2.7 / 5.4	\$ 9.61
135 x 32 - SB4	2.7 / 5.4	\$ 10.71
80 x 25 - SB5	2.7 / 5.4	\$ 5.89

SUBLACO RESTORATION

EST. 1981

Jarrah Colonial Skirting and Architraves

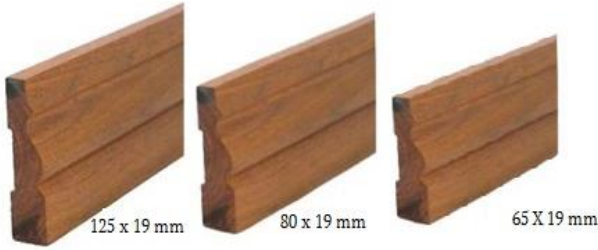

DIMENSIONS (MM)	LENGTHS (M)	L/M
125 x 19	Random Lengths	\$ 23.00
80 x 19	Random Lengths	\$ 14.10
65 x 19	Random Lengths	\$ 10.40

Jarrah Splayed Skirting and Architraves

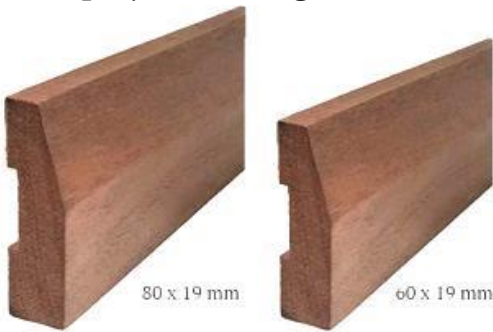

DIMENSIONS (MM)	LENGTHS (M)	L/M
80 x 19	Random Lengths	\$ 14.10
60 x 19	Random Lengths	\$ 9.70

Jarrah Single Bullnosed Skirting and Architraves

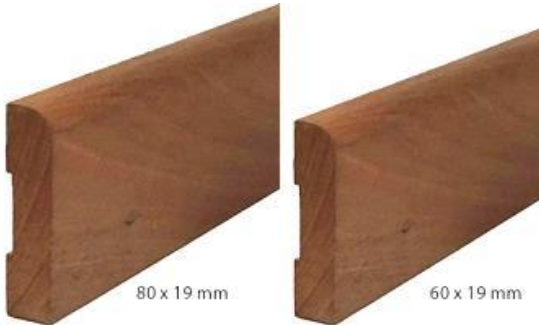

DIMENSIONS (MM)	LENGTHS (M)	L/M
80 x 19	Random Lengths	\$ 14.10
60 x 19	Random Lengths	\$ 9.70

Jarrah Double Bullnosed Architrave



DIMENSIONS (MM)	LENGTHS (M)	L/M
80 x 19	Random Lengths	\$ 14.10
60 x 19	Random Lengths	\$ 9.70
40 x 19	Random Lengths	\$ 3.90

SUBLACO RESTORATION

EST. 1981

Architraves

MEDIUM DENSITY FIBREBOARD (MDF), MOISTURE RESISTANCE (MR)

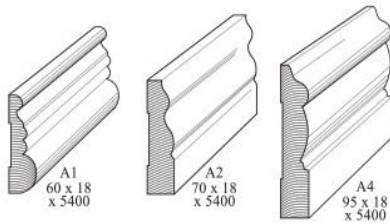

DIMENSIONS (MM)	LENGTHS (M)	L/M
60 x 18 - A1	2.7 / 5.4	\$ 3.68
70 x 18 - A2	2.7 / 5.4	\$ 3.94
95 x 18 - A4 (Primed)	2.7 / 5.4	\$ 5.59

Architraves

MEDIUM DENSITY FIBREBOARD (MDF), MOISTURE RESISTANCE (MR)

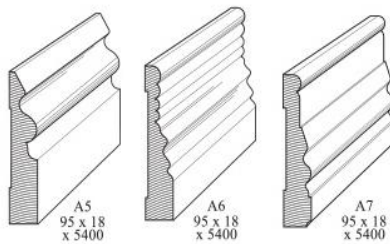

DIMENSIONS (MM)	LENGTHS (M)	L/M
95 x 18 - A5	2.7 / 5.4	\$ 4.91
95 x 18 - A6 (Primed)	2.7 / 5.4	\$ 5.59
95 x 18 - A7 (Primed)	2.7 / 5.4	\$ 5.59

Architraves

MEDIUM DENSITY FIBREBOARD (MDF), MOISTURE RESISTANCE (MR)

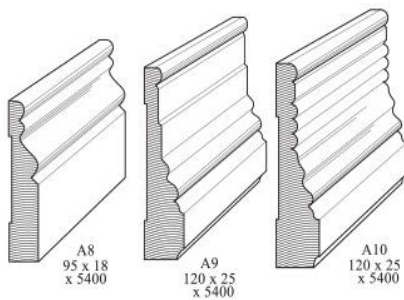

DIMENSIONS (MM)	LENGTHS (M)	L/M
95 x 18 x - A8 (Primed)	2.7 / 5.4	\$ 5.59
120 x 25 - A9	2.7 / 5.4	\$ 8.03
120 x 25 - A10	2.7 / 5.4	\$ 8.03

Architraves

MEDIUM DENSITY FIBREBOARD (MDF), MOISTURE RESISTANCE (MR)

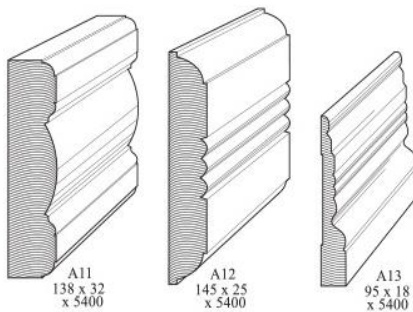

DIMENSIONS (MM)	LENGTHS (M)	L/M
138 x 32 - A11	2.7 / 5.4	\$ 10.71
145 x 25 - A12	2.7 / 5.4	\$ 9.40
95 x 18 - A13 (Primed)	2.7 / 5.4	\$ 5.59

SUBLACO RESTORATION

EST. 1981

Architraves

MEDIUM DENSITY FIBREBOARD (MDF), MOISTURE RESISTANCE (MR)

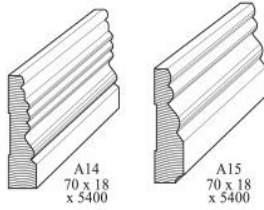

DIMENSIONS (MM)	LENGTHS (M)	L/M
70 x 18 - A14	2.7 / 5.4	\$ 3.94
70 x 18 - A15	2.7 / 5.4	\$ 3.94

WA Colonial Architraves

MEDIUM DENSITY FIBREBOARD (MDF), HIGH MOISTURE RESISTANCE (MR)

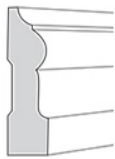

WA COLONIAL
67 / 87mm x 18mm

DIMENSIONS (MM)	LENGTHS (M)	L/M
67 x 18 (Primed)	2.7 / 5.4	\$ 2.64
87 x 18 (Primed)	2.7 / 5.4	\$ 3.54

Double Bullnosed Architraves

MEDIUM DENSITY FIBREBOARD (MDF), MOISTURE RESISTANCE (MR)

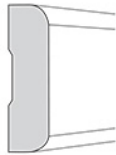

DOUBLE BULLNOSED ARCH
67mm x 18mm

DIMENSIONS (MM)	LENGTHS (M)	L/M
42 x 18 (Primed)	2.7 / 5.4	\$ 1.98
67 x 18 (Primed)	2.7 / 5.4	\$ 2.64

Single Bullnosed Architraves

MEDIUM DENSITY FIBREBOARD (MDF), MOISTURE RESISTANCE (MR)

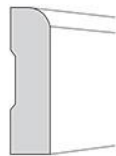

67 / 92 x 18mm

DIMENSIONS (MM)	LENGTHS (M)	L/M
67 x 18 (Primed)	2.7 / 5.4	\$ 2.64
92 x 18 (Primed)	2.7 / 5.4	\$ 3.54

SUBLACO RESTORATION

EST. 1981

Half Splayed Architraves

MEDIUM DENSITY FIBREBOARD (MDF), MOISTURE RESISTANCE (MR)

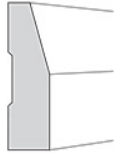

HALF SPLAYED
67/92/140 x 18mm

DIMENSIONS (MM)	LENGTHS (M)	L/M
67 x 18 (Primed)	2.7 / 5.4	\$ 2.64
92 x 18 (Primed)	2.7 / 5.4	\$ 3.54
140 x 18 (Primed)	2.7 / 5.4	\$ 5.96

Lambs Tongue Architraves

MEDIUM DENSITY FIBREBOARD (MDF), MOISTURE RESISTANCE (MR)



LAMBS TONGUE
67 / 92 x 18mm

DIMENSIONS (MM)	LENGTHS (M)	L/M
67 x 18 (Primed)	2.7 / 5.4	\$ 2.64
92 x 18 (Primed)	2.7 / 5.4	\$ 3.54

WA Federation Architraves

MEDIUM DENSITY FIBREBOARD (MDF), MOISTURE RESISTANCE (MR)



WA FEDERATION
65 / 80 x 18mm

DIMENSIONS (MM)	LENGTHS (M)	L/M
65 x 18 (Primed)	2.7 / 5.4	\$ 2.64
80 x 18 (Primed)	2.7 / 5.4	\$ 3.54

External Architraves & Skirtings

H3 LOSP TREATED PINE

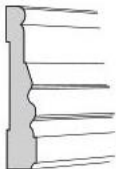

A7
90 x 18

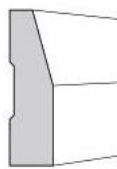

HALF SPLAYED
90 x 18

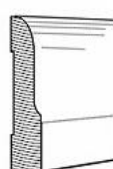

S13
90 x 18

DIMENSIONS (MM)	LENGTHS (M)	L/M
90 x 18 - A7	2.7 / 5.4	\$ 8.30
90 x 18 - Half Splayed	2.7 / 5.4	\$ 8.30
90 x 18 - S13	2.7 / 5.4	\$ 8.30
90 x 18 - Lambs Tongue	2.7 / 5.4	\$ 8.30
90 x 18 - Single Bullnose	2.7 / 5.4	\$ 8.30

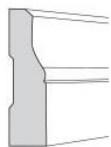

LAMBS TONGUE
90 x 18

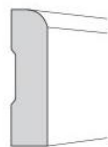

SINGLE BULLNOSED
90 x 18

SUBLACO RESTORATION

EST. 1981

Quads

Jarrah lengths available on request.



QUAD

12 x 12
18 x 18
32 x 32



SQUARE DRESSED

18 x 18

DIMENSIONS (MM)	LENGTHS (M)	L/M
18 x 18 - MDF (Primed)	2.7 / 5.4	\$ 1.61
32 x 32 - MDF	2.7 / 5.4	\$ 4.99
12 x 12 - Pine H3 LOSP (Primed)	2.7 / 5.4	\$ 1.40
18 x 18 - Pine H3 LOSP (Primed)	2.7 / 5.4	\$ 1.82
18 x 18 - Square Dressed Pine H3 (Primed)	2.7 / 5.4	\$ 1.82
12 x 12 - Jarrah		\$ 4.15
18 x 18 - Jarrah		\$ 5.70
32 x 32 - Jarrah		\$ 13.15

Door Stops

MEDIUM DENSITY FIBREBOARD (MDF), MOISTURE RESISTANCE (MR)



30 x 12
MDF



42 x 12
MDF



40 x 12
Jarrah

DIMENSIONS (MM)	LENGTHS (M)	L/M
30 x 12 - MDF (Primed)	2.7 / 5.4	\$ 1.47
42 x 12 - MDF (Primed)	2.7 / 5.4	\$ 1.58
40 x 12 - Jarrah	2.1 / 3.0	\$ 5.50

Scotias

MEDIUM DENSITY FIBREBOARD (MDF), MOISTURE RESISTANCE (MR)



DIMENSIONS (MM)	LENGTHS (M)	L/M
42 x 18 - MDF (Primed)	2.7 / 5.4	\$ 2.44
30 x 30 - Jarrah		\$ 11.15

Cornice / Crown Mouldings

MEDIUM DENSITY FIBREBOARD (MDF), MOISTURE RESISTANCE (MR)



C1
93 x 18

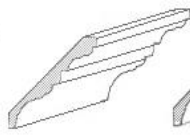

C13
128 x 18

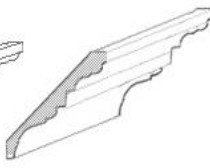

C14
180 x 18

DIMENSIONS (MM)	LENGTHS (M)	L/M
93 x 18 - C1	2.7 / 5.4	\$ 5.70
128 x 18 - C13	2.7 / 5.4	\$ 7.00
180 x 18 - C14	2.7 / 5.4	\$ 9.40

SUBLACO RESTORATION

EST. 1981

Nosing

MEDIUM DENSITY FIBREBOARD (MDF), MOISTURE RESISTANCE (MR)

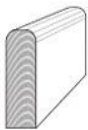

N1
100 x 32

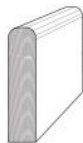

N2
125 x 32

DIMENSIONS (MM)	LENGTHS (M)	L/M
100 x 32 - N1	2.7 / 5.4	\$ 7.60
125 x 32 - N2	2.7 / 5.4	\$ 9.00

Nosing

MEDIUM DENSITY FIBREBOARD (MDF), MOISTURE RESISTANCE (MR)



N3
150 x 32



N5
175 x 32

DIMENSIONS (MM)	LENGTHS (M)	L/M
150 x 32 - N3	2.7 / 5.4	\$ 10.45
175 x 32 - N5	2.7 / 5.4	\$ 11.40

Nosing

MEDIUM DENSITY FIBREBOARD (MDF), MOISTURE RESISTANCE (MR)



DIMENSIONS (MM)	LENGTHS (M)	L/M
170 x 25 (Primed)	2.7 / 5.4	\$ 14.05

Square Dressed

MEDIUM DENSITY FIBREBOARD (MDF), MOISTURE RESISTANCE (MR)



30 x 12



42 x 12

DIMENSIONS (MM)	LENGTHS (M)	L/M
30 x 12 (Primed)	2.7 / 5.4	\$ 1.47
42 x 12 (Primed)	2.7 / 5.4	\$ 1.58

Square Dressed

MEDIUM DENSITY FIBREBOARD (MDF), MOISTURE RESISTANCE (MR)



42 x 18



67 x 18



92 x 18

DIMENSIONS (MM)	LENGTHS (M)	L/M
42 x 18 (Primed)	2.7 / 5.4	\$ 1.98
67 x 18 (Primed)	2.7 / 5.4	\$ 2.64
92 x 18 (Primed)	2.7 / 5.4	\$ 3.54
150 x 18 (Primed)	2.7 / 5.4	\$ 5.20

SUBLACO RESTORATION

EST. 1981

Picture Rails

MEDIUM DENSITY FIBREBOARD (MDF), MOISTURE RESISTANCE (MR)

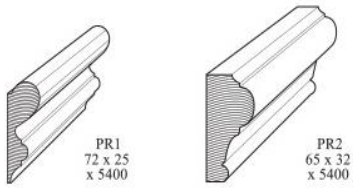

DIMENSIONS (MM)	LENGTHS (M)	L/M
72 x 25 - PR1	2.7 / 5.4	\$ 6.25
65 x 32 - PR2	2.7 / 5.4	\$ 7.20

Picture Rails

MEDIUM DENSITY FIBREBOARD (MDF), MOISTURE RESISTANCE (MR)

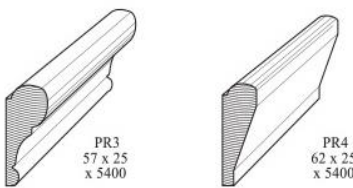

DIMENSIONS (MM)	LENGTHS (M)	L/M
57 x 25 - PR3	2.7 / 5.4	\$ 6.00
62 x 25 - PR4	2.7 / 5.4	\$ 6.00

Picture Rails

MEDIUM DENSITY FIBREBOARD (MDF), MOISTURE RESISTANCE (MR)

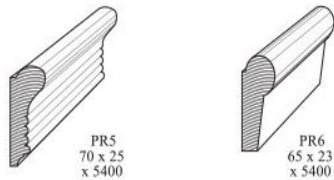

DIMENSIONS (MM)	LENGTHS (M)	L/M
70 x 25 - PR5	2.7 / 5.4	\$ 6.00
65 x 23 - PR6	2.7 / 5.4	\$ 6.00

Dado Rail

MEDIUM DENSITY FIBREBOARD (MDF), MOISTURE RESISTANCE (MR)

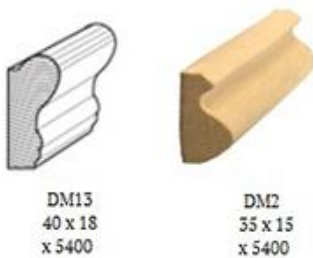

DIMENSIONS (MM)	LENGTHS (M)	L/M
40 x 18 - DM13	2.7 / 5.4	\$ 2.40
35 x 15 - DM2	2.7 / 5.4	\$ 2.30

Bolection Mould

MEDIUM DENSITY FIBREBOARD (MDF), MOISTURE RESISTANCE (MR)



DIMENSIONS (MM)	LENGTHS (M)	L/M
42 x 18 (Primed)	2.7	\$ 1.72

SUBLACO RESTORATION

EST. 1981

Stringers

MEDIUM DENSITY FIBREBOARD (MDF), MOISTURE RESISTANCE (MR)



450 x 18 x 5400

DIMENSIONS (MM)	LENGTHS (M)	L/M
450 x 18	2.7 / 5.4	\$ 16.90

Panels

MEDIUM DENSITY FIBREBOARD (MDF), MOISTURE RESISTANCE (MR)



5400 x 1200



2400 x 1200

DIMENSIONS (MM)	PER SHEET
5400 x 1200 x 32	\$ 325.00
5400 x 1200 x 25	\$ 260.00
5400 x 1200 x 18	\$ 155.45
5400 x 1200 x 12	\$ 148.00
2400 x 1200 x 32	\$ 146.00
2400 x 1200 x 25	\$ 115.60
2400 x 1200 x 18	\$ 67.30