

SUBIACO RESTORATION

EST. 1981

Mouldings

RETAIL PRICE LIST

SUBIACO RESTORATION - M
SR
1981 - 1986

SUPPLYING WA BUILDINGS SINCE 1981

Timber | Structural Timber | Decking | Mouldings | Flooring | Doors, Windows & Joinery
Heating | Architectural Hardware | Lighting & Ceilings | Cooking | Bathroom | Homewares

SUBLACO RESTORATION

EST. 1981

Skirtings

MEDIUM DENSITY FIBREBOARD (MDF), MOISTURE RESISTANCE (MR)

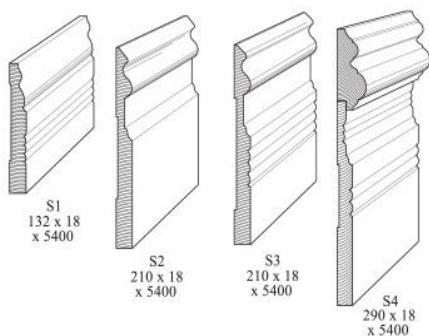

DIMENSIONS (MM)	LENGTHS (M)	L/M
132 x 18 - S1 (Primed)	2.7 / 5.4	\$ 6.75
210 x 18 - S2 (Primed)	2.7 / 5.4	\$ 9.24
210 x 18 - S3	2.7 / 5.4	\$ 9.24
290 x 18 - S4	2.7 / 5.4	\$ 19.45

Skirtings

MEDIUM DENSITY FIBREBOARD (MDF), MOISTURE RESISTANCE (MR)

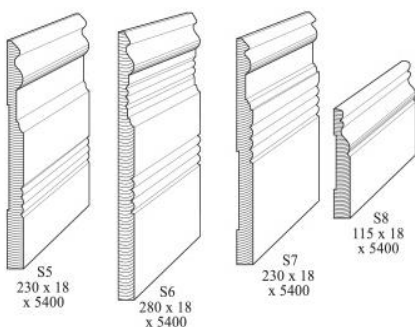

DIMENSIONS (MM)	LENGTHS (M)	L/M
230 x 18 - S5 (Primed)	2.7 / 5.4	\$ 10.34
280 x 18 - S6	2.7 / 5.4	\$ 15.55
230 x 18 - S7	2.7 / 5.4	\$ 10.34
115 x 18 - S8 (Primed)	2.7 / 5.4	\$ 5.76

Skirtings

MEDIUM DENSITY FIBREBOARD (MDF), MOISTURE RESISTANCE (MR)

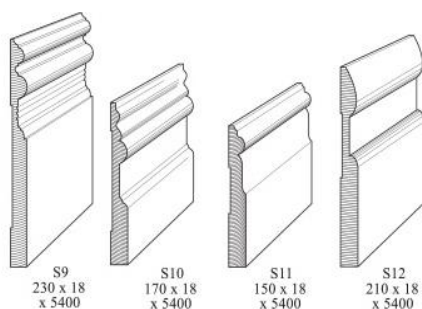

DIMENSIONS (MM)	LENGTHS (M)	L/M
230 x 18 - S9	2.7 / 5.4	\$ 11.05
170 x 18 - S10 (Primed)	2.7 / 5.4	\$ 7.15
150 x 18 - S11 (Primed)	2.7 / 5.4	\$ 7.00
210 x 18 - S12 (Primed)	2.7 / 5.4	\$ 9.24

SUBLACO RESTORATION

EST. 1981

Skirtings

MEDIUM DENSITY FIBREBOARD (MDF), MOISTURE RESISTANCE (MR)

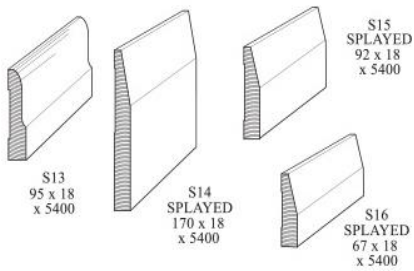

DIMENSIONS (MM)	LENGTHS (M)	L/M
95 x 18 - S13 (Primed)	2.7 / 5.4	\$ 4.71
170 x 18 - S14 Splayed (Primed)	2.7 / 5.4	\$ 7.15
92 x 18 - S15 Splayed (Primed)	2.7 / 5.4	\$ 4.71
67 x 18 - S16 Splayed	2.7 / 5.4	\$ 3.70

WA Colonial Skirtings

MEDIUM DENSITY FIBREBOARD (MDF), MOISTURE RESISTANCE (MR)

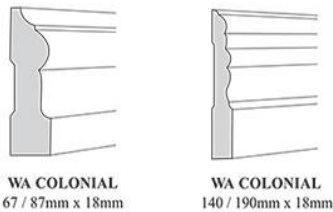

DIMENSIONS (MM)	LENGTHS (M)	L/M
67 x 18 (Primed)	2.7 / 5.4	\$ 2.16
87 x 18 (Primed)	2.7 / 5.4	\$ 3.10
140 x 18 (Primed)	2.7 / 5.4	\$ 4.60
190 x 18 (Primed)	2.7 / 5.4	\$ 7.13

Single Bullnosed Skirtings

MEDIUM DENSITY FIBREBOARD (MDF), MOISTURE RESISTANCE (MR)

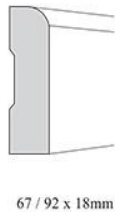

DIMENSIONS (MM)	LENGTHS (M)	L/M
67 x 18 (Primed)	2.7 / 5.4	\$ 2.16
92 x 18 (Primed)	2.7 / 5.4	\$ 3.10

Half Splayed Skirtings

MEDIUM DENSITY FIBREBOARD (MDF), MOISTURE RESISTANCE (MR)

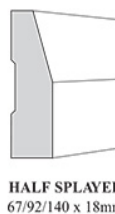

DIMENSIONS (MM)	LENGTHS (M)	L/M
67 x 18 (Primed)	2.7 / 5.4	\$ 2.16
92 x 18 (Primed)	2.7 / 5.4	\$ 3.10
140 x 18 (Primed)	2.7 / 5.4	\$ 4.60

SUBLACO RESTORATION

EST. 1981

Lambs Tounge Skirtings

MEDIUM DENSITY FIBREBOARD (MDF), MOISTURE RESISTANCE (MR)

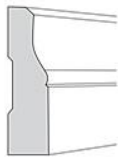

LAMBS TONGUE
67 / 92 / 140 x 18mm

DIMENSIONS (MM)	LENGTHS (M)	L/M
67 x 18 (Primed)	2.7 / 5.4	\$ 2.16
92 x 18 (Primed)	2.7 / 5.4	\$ 3.10
140 x 18 (Primed)	2.7 / 5.4	\$ 4.60

WA Federation Skirtings

MEDIUM DENSITY FIBREBOARD (MDF), MOISTURE RESISTANCE (MR)

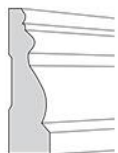

WA FEDERATION
65 / 80 / 125 x 18mm

DIMENSIONS (MM)	LENGTHS (M)	L/M
65 x 18 (Primed)	2.7 / 5.4	\$ 2.16
80 x 18 (Primed)	2.7 / 5.4	\$ 3.10
125 x 18 (Primed)	2.7 / 5.4	\$ 4.49

Skirting Blocks

MEDIUM DENSITY FIBREBOARD (MDF), MOISTURE RESISTANCE (MR)

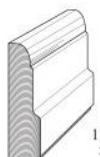

SB1
115 x 32
x 5400

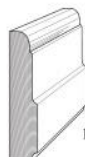

SB2
140 x 32
x 5400

DIMENSIONS (MM)	LENGTHS (M)	L/M
115 x 32 - SB1	2.7 / 5.4	\$ 9.15
140 x 32 - SB2	2.7 / 5.4	\$ 10.20

Skirting Blocks

MEDIUM DENSITY FIBREBOARD (MDF), MOISTURE RESISTANCE (MR)



SB3
115 x 32
x 5400

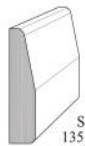

SB4
135 x 32
x 5400



SB5
80 x 25
x 5400

DIMENSIONS (MM)	LENGTHS (M)	L/M
115 x 32 - SB3	2.7 / 5.4	\$ 9.15
135 x 32 - SB4	2.7 / 5.4	\$ 10.20
80 x 25 - SB5	2.7 / 5.4	\$ 5.60

SUBLACO RESTORATION

EST. 1981

Architraves

MEDIUM DENSITY FIBREBOARD (MDF), MOISTURE RESISTANCE (MR)

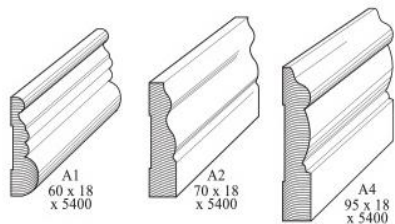

DIMENSIONS (MM)	LENGTHS (M)	L/M
60 x 18 - A1	2.7 / 5.4	\$ 3.50
70 x 18 - A2	2.7 / 5.4	\$ 3.75
95 x 18 - A4 (Primed)	2.7 / 5.4	\$ 4.71

Architraves

MEDIUM DENSITY FIBREBOARD (MDF), MOISTURE RESISTANCE (MR)

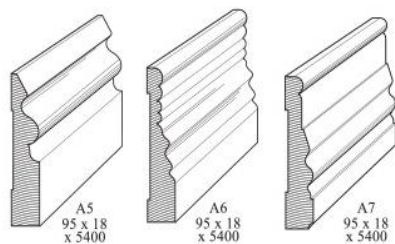

DIMENSIONS (MM)	LENGTHS (M)	L/M
95 x 18 - A5	2.7 / 5.4	\$ 4.71
95 x 18 - A6 (Primed)	2.7 / 5.4	\$ 4.71
95 x 18 - A7 (Primed)	2.7 / 5.4	\$ 4.71

Architraves

MEDIUM DENSITY FIBREBOARD (MDF), MOISTURE RESISTANCE (MR)

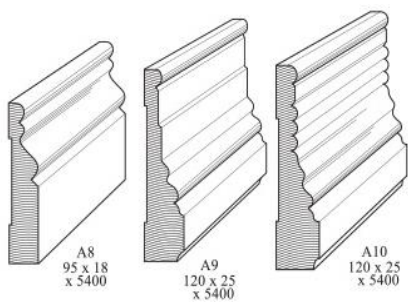

DIMENSIONS (MM)	LENGTHS (M)	L/M
95 x 18 x - A8 (Primed)	2.7 / 5.4	\$ 4.71
120 x 25 - A9	2.7 / 5.4	\$ 7.65
120 x 25 - A10	2.7 / 5.4	\$ 7.65

Architraves

MEDIUM DENSITY FIBREBOARD (MDF), MOISTURE RESISTANCE (MR)

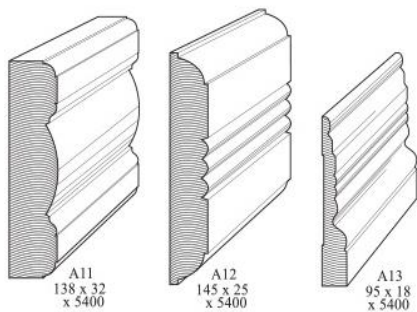

DIMENSIONS (MM)	LENGTHS (M)	L/M
138 x 32 - A11	2.7 / 5.4	\$ 10.20
145 x 25 - A12	2.7 / 5.4	\$ 8.95
95 x 18 - A13 (Primed)	2.7 / 5.4	\$ 4.71

SUBLACO RESTORATION

EST. 1981

Architraves

MEDIUM DENSITY FIBREBOARD (MDF), MOISTURE RESISTANCE (MR)

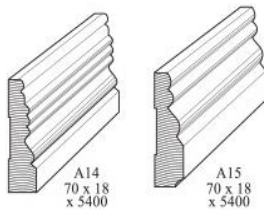

DIMENSIONS (MM)	LENGTHS (M)	L/M
70 x 18 - A14	2.7 / 5.4	\$ 3.75
70 x 18 - A15	2.7 / 5.4	\$ 3.75

WA Colonial Architraves

MEDIUM DENSITY FIBREBOARD (MDF), HIGH MOISTURE RESISTANCE (MR)

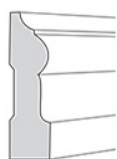

WA COLONIAL
67 / 87mm x 18mm

DIMENSIONS (MM)	LENGTHS (M)	L/M
67 x 18 (Primed)	2.7 / 5.4	\$ 2.16
87 x 18 (Primed)	2.7 / 5.4	\$ 3.10

Double Bullnosed Architraves

MEDIUM DENSITY FIBREBOARD (MDF), MOISTURE RESISTANCE (MR)

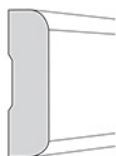

DOUBLE BULLNOSED ARCH
67mm x 18mm

DIMENSIONS (MM)	LENGTHS (M)	L/M
42 x 18 (Primed)	2.7 / 5.4	\$ 1.63
67 x 18 (Primed)	2.7 / 5.4	\$ 2.16

Single Bullnosed Architraves

MEDIUM DENSITY FIBREBOARD (MDF), MOISTURE RESISTANCE (MR)

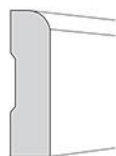

67 / 92 x 18mm

DIMENSIONS (MM)	LENGTHS (M)	L/M
67 x 18 (Primed)	2.7 / 5.4	\$ 2.16
92 x 18 (Primed)	2.7 / 5.4	\$ 3.10

SUBLACO RESTORATION

EST. 1981

Half Splayed Architraves

MEDIUM DENSITY FIBREBOARD (MDF), MOISTURE RESISTANCE (MR)

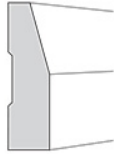

HALF SPLAYED
67/92/140 x 18mm

DIMENSIONS (MM)	LENGTHS (M)	L/M
67 x 18 (Primed)	2.7 / 5.4	\$ 2.16
92 x 18 (Primed)	2.7 / 5.4	\$ 3.10
140 x 18 (Primed)	2.7 / 5.4	\$ 4.60

Lambs Tounge Architraves

MEDIUM DENSITY FIBREBOARD (MDF), MOISTURE RESISTANCE (MR)



LAMBS TONGUE
67 / 92 x 18mm

DIMENSIONS (MM)	LENGTHS (M)	L/M
67 x 18 (Primed)	2.7 / 5.4	\$ 2.16
92 x 18 (Primed)	2.7 / 5.4	\$ 3.10

WA Federation Architraves

MEDIUM DENSITY FIBREBOARD (MDF), MOISTURE RESISTANCE (MR)



WA FEDERATION
65 / 80 x 18mm

DIMENSIONS (MM)	LENGTHS (M)	L/M
65 x 18 (Primed)	2.7 / 5.4	\$ 2.16
80 x 18 (Primed)	2.7 / 5.4	\$ 3.10

External Architraves & Skirtings

H3 LOSP TREATED PINE

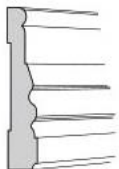

A7
88 x 18

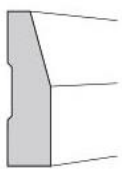

HALF SPLAYED
88 x 18

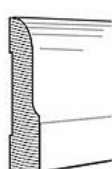

S13
88 X 18

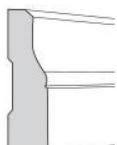

LAMBS TONGUE
88 x 18
x 5400

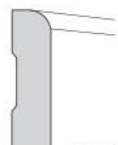

SINGLE BULLNOSED
88 x 18
x 5400

DIMENSIONS (MM)	LENGTHS (M)	L/M
88 x 18 - A7	2.7 / 5.4	\$ 7.90
88 x 18 - Half Splayed	2.7 / 5.4	\$ 7.90
88 x 18 - S13	2.7 / 5.4	\$ 7.90
88 x 18 - Lambs Tounge	2.7 / 5.4	\$ 7.90
88 x 18 - Single Bullnose	2.7 / 5.4	\$ 7.90

SUBLACO RESTORATION

EST. 1981

Quads

MEDIUM DENSITY FIBREBOARD (MDF), MOISTURE RESISTANCE (MR)

Jarrah lengths available on request.



DIMENSIONS (MM)	LENGTHS (M)	L/M
18 x 18 - MDF (Primed)	2.7 / 5.4	\$ 1.28
32 x 32 - MDF	2.7 / 5.4	\$ 4.75
12 x 12 - Jarrah		\$ 3.95
18 x 18 - Jarrah		\$ 5.45
32 x 32 - Jarrah		\$ 12.50

Door Stops

MEDIUM DENSITY FIBREBOARD (MDF), MOISTURE RESISTANCE (MR)



30 x 12
MDF



42 x 12
MDF



40 x 12
Jarrah

DIMENSIONS (MM)	LENGTHS (M)	L/M
30 x 12 - MDF (Primed)	2.7 / 5.4	\$ 1.17
42 x 12 - MDF (Primed)	2.7 / 5.4	\$ 1.28
40 x 12 - Jarrah	2.1 / 3.0	\$ 5.25

Scotias

MEDIUM DENSITY FIBREBOARD (MDF), MOISTURE RESISTANCE (MR)



DIMENSIONS (MM)	LENGTHS (M)	L/M
42 x 18 - MDF (Primed)	2.7 / 5.4	\$ 2.00
30 x 30 - Jarrah		\$ 10.60

Cornices

MEDIUM DENSITY FIBREBOARD (MDF), MOISTURE RESISTANCE (MR)



C1
93 x 18

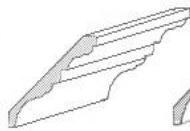

C13
128 x 18

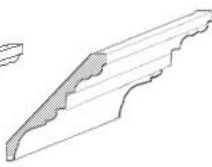

C14
180 x 18

DIMENSIONS (MM)	LENGTHS (M)	L/M
93 x 18 - C1	2.7 / 5.4	\$ 5.45
128 x 18 - C13	2.7 / 5.4	\$ 6.65
180 x 18 - C14	2.7 / 5.4	\$ 8.95

SUBLACO RESTORATION

EST. 1981

Nosing

MEDIUM DENSITY FIBREBOARD (MDF), MOISTURE RESISTANCE (MR)

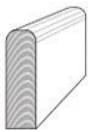

N1
100 x 32

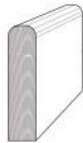

N2
125 x 32

DIMENSIONS (MM)	LENGTHS (M)	L/M
100 x 32 - N1	2.7 / 5.4	\$ 7.25
125 x 32 - N2	2.7 / 5.4	\$ 8.55

Nosing

MEDIUM DENSITY FIBREBOARD (MDF), MOISTURE RESISTANCE (MR)



N3
150 x 32



N5
175 x 32

DIMENSIONS (MM)	LENGTHS (M)	L/M
150 x 32 - N3	2.7 / 5.4	\$ 9.95
175 x 32 - N5	2.7 / 5.4	\$ 10.85

Nosing

MEDIUM DENSITY FIBREBOARD (MDF), MOISTURE RESISTANCE (MR)



DIMENSIONS (MM)	LENGTHS (M)	L/M
170 x 25 (Primed)	2.4 / 4.8	\$ 11.50

Square Dressed

MEDIUM DENSITY FIBREBOARD (MDF), MOISTURE RESISTANCE (MR)



30 x 12



42 x 12

DIMENSIONS (MM)	LENGTHS (M)	L/M
30 x 12 (Primed)	2.7 / 5.4	\$ 1.17
42 x 12 (Primed)	2.7 / 5.4	\$ 1.28

Square Dressed

MEDIUM DENSITY FIBREBOARD (MDF), MOISTURE RESISTANCE (MR)



42 x 18



67 x 18



92 x 18

DIMENSIONS (MM)	LENGTHS (M)	L/M
42 x 18 (Primed)	2.7 / 5.4	\$ 1.63
67 x 18 (Primed)	2.7 / 5.4	\$ 2.16
92 x 18 (Primed)	2.7 / 5.4	\$ 3.10

SUBLACO RESTORATION

EST. 1981

Stringers

MEDIUM DENSITY FIBREBOARD (MDF), MOISTURE RESISTANCE (MR)

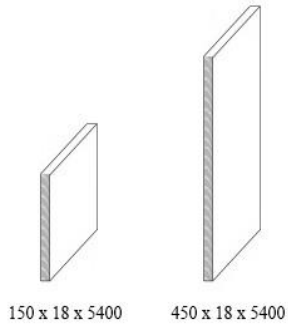

DIMENSIONS (MM)	LENGTHS (M)	L/M
450 x 18	5.4	\$ 16.09
150 x 18	5.4	\$ 6.49

Panels

MEDIUM DENSITY FIBREBOARD (MDF), MOISTURE RESISTANCE (MR)



5400 x 1200



2400 x 1200

DIMENSIONS (MM)	PER SHEET
5400 x 1200 x 32	\$ 295.00
5400 x 1200 x 25	\$ 225.00
5400 x 1200 x 18	\$ 129.00
5400 x 1200 x 12	\$ 115.00
2400 x 1200 x 32	\$ 131.00
2400 x 1200 x 25	\$ 100.00
2400 x 1200 x 18	\$ 56.00

SUBLACO RESTORATION

EST. 1981

Picture Rails

MEDIUM DENSITY FIBREBOARD (MDF), MOISTURE RESISTANCE (MR)

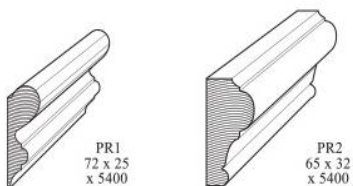

DIMENSIONS (MM)	LENGTHS (M)	L/M
72 x 25 - PR1	2.7 / 5.4	\$ 5.95
65 x 32 - PR2	2.7 / 5.4	\$ 6.85

Picture Rails

MEDIUM DENSITY FIBREBOARD (MDF), MOISTURE RESISTANCE (MR)

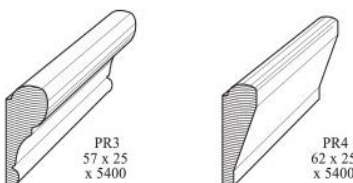

DIMENSIONS (MM)	LENGTHS (M)	L/M
57 x 25 - PR3	2.7 / 5.4	\$ 5.70
62 x 25 - PR4	2.7 / 5.4	\$ 5.70

Picture Rails

MEDIUM DENSITY FIBREBOARD (MDF), MOISTURE RESISTANCE (MR)

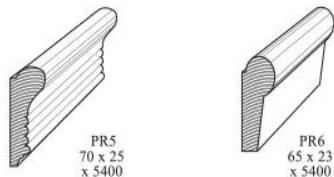

DIMENSIONS (MM)	LENGTHS (M)	L/M
70 x 25 - PR5	2.7 / 5.4	\$ 5.70
65 x 23 - PR6	2.7 / 5.4	\$ 5.70

Dado Rail

MEDIUM DENSITY FIBREBOARD (MDF), MOISTURE RESISTANCE (MR)

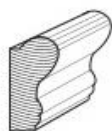

DM13
40 x 18
x 5400

DIMENSIONS (MM)	LENGTHS (M)	L/M
40 x 18 - DM13	2.7 / 5.4	\$ 2.30